

OV7670/OV7171 CMOS VGA (640x480) CameraChip™ Implementation Guide

Last Modified: 2 September 2005
Document Version: 1.0

Revision Number	Date	Revision
1.0	09/02/05	Initial Release

This document is provided "as is" with no warranties whatsoever, including any warranty of merchantability, non-infringement, fitness for any particular purpose, or any warranty otherwise arising out of any proposal, specification, or sample.

OmniVision Technologies, Inc. disclaims all liability, including liability for infringement of any proprietary rights, relating to the use of information in this document. No license, expressed or implied, by estoppel or otherwise, to any intellectual property rights is granted herein.

* Third-party brands, names, and trademarks are the property of their respective owners.

Note:

The information contained in this document is considered proprietary to OmniVision Technologies, Inc. This information may be distributed only to individuals or organizations authorized by OmniVision Technologies, Inc. to receive said information. Individuals and/or organizations are not allowed to re-distribute said information.

Table of Contents

Section 1, Introduction	7
1.1 Function Description	7
Section 2, Image Sensor Array	8
2.1 Resolution Formats	8
Section 3, Timing Generator	12
3.1 Array Control	12
3.2 Frame Rate Timing	12
3.2.1 Clock Pre-scalar	12
3.2.2 Dummy Pixel Adjustment	13
3.2.3 Dummy Row Adjustment	13
3.3 Exposure Control	14
3.3.1 Exposure Time	14
3.3.2 Banding Filter	15
3.3.3 Manual Exposure Control	16
3.3.4 Automatic Exposure Control Mode (AEC)	16
3.4 External Timing Output	20
3.4.1 Sync Signal	20
3.4.2 Strobe Signal	21
Section 4, Analog Signal Processor	25
4.1 Gain Control	25
4.1.1 Manual Gain Control	25
4.1.2 Automatic Gain Control (AGC)	27
4.2 Black Level Calibration	28
4.2.1 Automatic Black Level Calibration (ABLC)	28
4.2.2 Manual Black Level Calibration	28
Section 5, Digital Signal Processor (DSP)	29
5.1 White Balance Control	29
5.1.1 Automatic White Balance Control	30
5.1.2 Manual White Balance	30
5.2 Gamma Control	31
5.2.1 Gamma Slope Calculation	32

5.3	Color Matrix	32
5.3.1	Color Matrix Control	32
5.4	Sharpness Control	34
5.5	De-Noise	34
5.6	Auto Color Saturation Adjustment	35
5.7	Defect Pixel Correction	35
5.8	Lens Correction	35
5.9	Brightness and Contrast Control	37
Section 6, Image Scaler		38
6.1	Image Scaling	38
6.2	Pixel Clock Divider	40
6.3	Pixel Clock Delay	40
6.4	Horizontal/Vertical Scaling Ratio	40
6.5	Windowing	41
6.6	Data Formatting	42
Section 7, Digital Video Port		43
7.1	Drive Current	43
7.2	Tri-state Enable	43
Section 8, SCCB Interface		44
8.1	Control Functions	44
8.1.1	Register Reset	44
8.1.2	Standby Mode Enable	44
8.2	Register Set	45
Section 9, Prototyping and Evaluation Modules		63
9.1	OV7670/OV7171EAA Prototyping Module	63
9.2	OV7670/OV7171ECX USB 2.0 Evaluation Module	63
Section 10, Lens selection		63
Section 11, OV7670/OV7171 Bug List		63
Appendix A, Reference SCCB Settings		64

List of Figures

Figure 1-1	OV7670/OV7171 Functional Block Diagram	7
Figure 3-1	Average-based AEC/AGC	17
Figure 3-2	Histogram-Based AEC Control	18
Figure 3-3	Xenon Flash Mode	22
Figure 3-4	LED 1 Mode – One Pulse Output	23
Figure 3-5	LED 1 Mode – Multiple Pulse Output	23
Figure 3-6	LED 2 Mode	24
Figure 5-1	Gamma Curve	31
Figure 5-2	Lens Correction	35
Figure 6-1	Image Scaling Circuit	38
Figure 6-2	Example of Windowing	41
Figure 6-3	MSB/LSB Output Data Swap	42

List of Tables

Table 2-1	OV7670/OV7171 Output Formats	8
Table 2-2	Resolution Register Settings.....	9
Table 3-1	Scan Direction Control.....	12
Table 3-2	Clock Pre-Scalar Control.....	13
Table 3-3	VGA Frame Rate	13
Table 3-4	Dummy Pixel and Row.....	14
Table 3-5	Exposure and Banding Filter.....	15
Table 3-6	Exposure Control Mode.....	17
Table 3-7	Average-based AEC/AGC Registers	17
Table 3-8	Histogram-based AEC Related Registers.....	18
Table 3-9	Histogram-based AEC Algorithm Adjustment Controls.....	19
Table 3-10	Sync Signal Related Registers.....	20
Table 3-11	Flashlight Modes.....	21
Table 3-12	Xenon Flash Pulse Width Control	22
Table 4-1	Total Gain to Control Bit Correlation.....	26
Table 4-2	AGC General Controls.....	27
Table 4-3	ABLC Control Registers.....	28
Table 5-1	White Balance Control Registers	29
Table 5-2	AWB Control Registers	30
Table 5-3	Gamma Related Registers and Parameters.....	31
Table 5-4	Color Matrix Related Registers and Parameters	33
Table 5-5	Sharpness Control Registers	34
Table 5-6	De-Noise Related Registers and Parameters	34
Table 5-7	Auto Color Saturation Adjustment Related Registers	35
Table 5-8	Lens Shading Correction Registers and Parameters	36
Table 5-9	Brightness and Contrast Related Registers	37
Table 6-1	Image Scaling Control Related Registers and Parameters	39
Table 6-2	Down Sampling Control Related Registers and Parameters.....	39
Table 6-3	Pixel Clock Divider	40
Table 6-4	Windowing Control Registers	41

Table 6-5	RGB555 and RGB565 Output Format Controls	42
Table 7-1	Output Drive Current	43
Table 7-2	Tri-State Enable	43
Table 8-1	SCCB Control Functions	44
Table 8-2	Device Control Register List	45

Preliminary

1 Introduction

This general application note is provided as a brief overview of the settings required for programming the OV7670/OV7171 CAMERACHIP™. The Implementation Guide supplies the design engineer with quick-start tips for successful design solutions.

The [OV7670/OV7171 Datasheet](#) provides complete information on the features, pin descriptions, and registers of the OV7670/OV7171. The Implementation Guide is intended to complement the [OV7670/OV7171 Datasheet](#) with considerations for PCB layout, register configurations, and timing parameters for rapid product design and deployment.

1.1 Function Description

Figure 1-1 shows the functional block diagram of the OV7670/OV7171 image sensor. The OV7670/OV7171 includes:

- [Image Sensor Array](#) (656 x 488 pixels total, including dummy pixels)
- [Analog Signal Processor](#)
- [A/D Converters](#)
- [Digital Signal Processor \(DSP\)](#)
- [Timing Generator](#)
- [Light Frequency Auto Detection](#)
- [Test Pattern Generator](#)
- [Image Scaler](#)
- [Digital Video Port](#)
- [Exposure/Gain Control](#)
- [SCCB Interface](#)

Figure 1-1 OV7670/OV7171 Functional Block Diagram

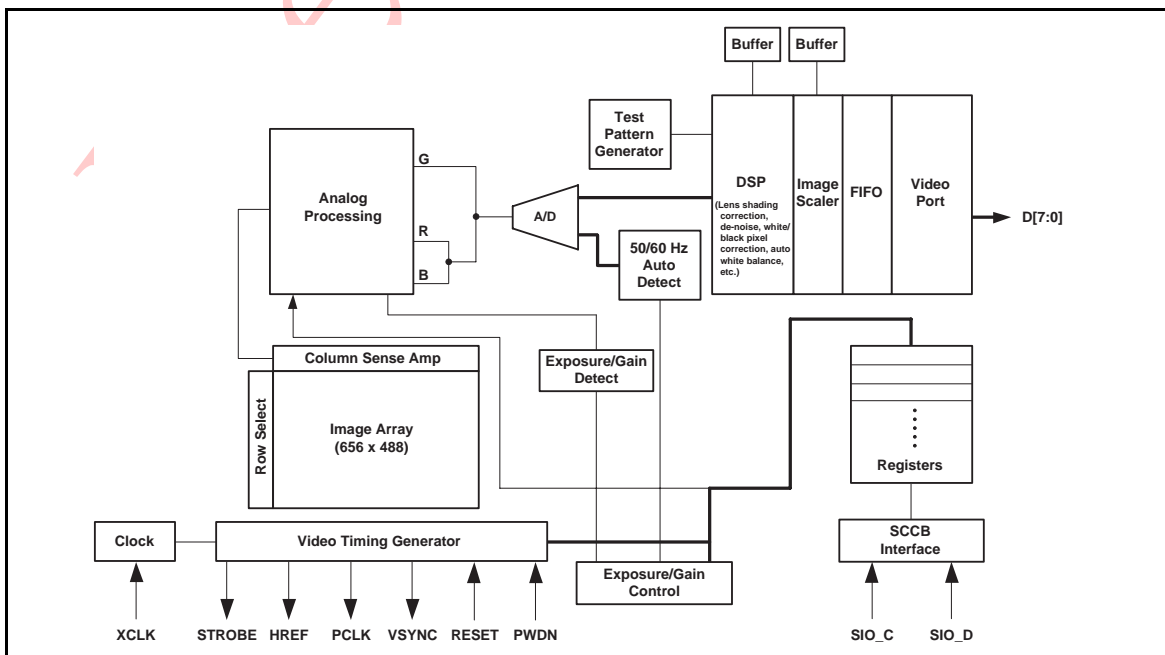

2 Image Sensor Array

The OV7670/OV7171 CAMERACHIPS has an image array size of 656 columns by 488 rows (320,128 pixels).

The pixel cells themselves are identical, but have RGB color filters arranged in a row-alternating BG/GR Bayer Pattern. The final YUV/YCbCr image uses this filter pattern to interpolate each pixel's BG or GR color from the light striking the cell directly, as well as from the light striking the surrounding cells. The 'Raw Bayer RGB' image does not have any image processing.

The OV7670/OV7171 supports Raw Bayer RGB, processed Bayer RGB, YUV/CbCr, GRB, and RGB555/565 format. GRB and RGB555/565 formats are converted from YUV/YCbCr. [Table 2-1](#) lists all OV7670/OV7171 output formats.

Table 2-1. OV7670/OV7171 Output Formats

Format	Pixel Data Output	Register Settings			
		COM7[2]	COM7[0]	COM15[5]	COM15[4]
Raw Bayer RGB	8-bit R or 8-bit G or 8-bit B	0	1	x	0
Processed Bayer RGB	8-bit R or 8-bit G or 8-bit B	1	1	x	0
YUV/YCbCr 4:2:2	8-bit Y, 8-bit U or 8-bit Y, 8-bit V	0	0	x	0
GRB 4:2:2	8-bit G, 8-bit R or 8-bit G, 8-bit B	1	0	x	0
RGB565	5-bit R, 6-bit G, 5-bit B	1	0	0	1
RGB555	5-bit R, 5-bit G, 5-bit B	1	0	1	1

2.1 Resolution Formats

In Raw Bayer RGB format, the OV7670/OV7171 CAMERACHIP supports VGA resolution. In Processed Bayer RGB format, the OV7670/OV7171 CAMERACHIP supports VGA and QVGA resolution. In YUV/YCbCr, GRB and RGB555/565 format, the OV7670/OV7171 CAMERACHIP supports VGA (640x480) and any resolution below CIF using the Image Scaler.

The OV7670/OV7171 CAMERACHIP also has a set of pre-defined Scaler settings for QVGA, CIF and QCIF resolutions. Setting registers [COM7\[4\]](#) (0x12), [COM7\[5\]](#), and [COM7\[3\]](#) to 1 selects these pre-defined resolution, respectively. To manually change the pre-defined scalar settings, set registers [COM14\[3\]](#) (0x3E) and [SCALING_PCLK_DELAY\[7\]](#) (0xA2). After selecting the desired resolution, the output window settings (registers [HSTART](#) (0x17), [HSTOP](#) (0x18), [HREF\[5:0\]](#) (0x32), [VSTRT](#) (0x19), [VSTOP](#) (0x1A) and [VREF\[3:0\]](#) (0x03)) must be adjusted appropriately. To adjust these settings, set register [TSLB\[0\]](#) (0x3A) to 0.

[Table 2-2](#) provides the Scaler settings for most common resolutions. Refer to the section “[Image Scaler](#)” on [page 38](#) for more details.

Table 2-2. Resolution Register Settings (Sheet 1 of 3)

Resolution	Register	Address	Value	Description (24 MHz Input Clock)
VGA	CLKRC	0x11	0x01	30 fps VGA YUV mode
	COM7	0x12	0x00	
	COM3	0x0C	0x00	
	COM14	0x3E	0x00	
	SCALING_XSC	0x70	0x3A	
	SCALING_YSC	0x71	0x35	
	SCALING_DCWCTR	0x72	0x11	
	SCALING_PCLK_DIV	0x73	0xF0	
	SCALING_PCLK_DELAY	0xA2	0x02	
QVGA	CLKRC	0x11	0x01	30 fps QVGA YUV mode
	COM7	0x12	0x00	
	COM3	0x0C	0x04	
	COM14	0x3E	0x19	
	SCALING_XSC	0x70	0x3A	
	SCALING_YSC	0x71	0x35	
	SCALING_DCWCTR	0x72	0x11	
	SCALING_PCLK_DIV	0x73	0xF1	
	SCALING_PCLK_DELAY	0xA2	0x02	
QQVGA	CLKRC	0x11	0x01	30 fps QQVGA YUV mode
	COM7	0x12	0x00	
	COM3	0x0C	0x04	
	COM14	0x3E	0x1A	
	SCALING_XSC	0x70	0x3A	
	SCALING_YSC	0x71	0x35	
	SCALING_DCWCTR	0x72	0x22	
	SCALING_PCLK_DIV	0x73	0xF2	
	SCALING_PCLK_DELAY	0xA2	0x02	

Table 2-2. Resolution Register Settings (Sheet 2 of 3)

Resolution	Register	Address	Value	Description (24 MHz Input Clock)
CIF	CLKRC	0x11	0x01	30 fps CIF YUV mode
	COM7	0x12	0x00	
	COM3	0x0C	0x08	
	COM14	0x3E	0x11	
	SCALING_XSC	0x70	0x3A	
	SCALING_YSC	0x71	0x35	
	SCALING_DCWCTR	0x72	0x11	
	SCALING_PCLK_DIV	0x73	0xF1	
	SCALING_PCLK_DELAY	0xA2	0x02	
QCIF	CLKRC	0x11	0x01	30 fps QCIF YUV mode
	COM7	0x12	0x00	
	COM3	0x0C	0x0C	
	COM14	0x3E	0x11	
	SCALING_XSC	0x70	0x3A	
	SCALING_YSC	0x71	0x35	
	SCALING_DCWCTR	0x72	0x11	
	SCALING_PCLK_DIV	0x73	0xF1	
	SCALING_PCLK_DELAY	0xA2	0x52	
QQCIF	CLKRC	0x11	0x01	30 fps QQCIF YUV mode
	COM7	0x12	0x00	
	COM3	0x0C	0x0C	
	COM14	0x3E	0x12	
	SCALING_XSC	0x70	0x3A	
	SCALING_YSC	0x71	0x35	
	SCALING_DCWCTR	0x72	0x22	
	SCALING_PCLK_DIV	0x73	0xF2	
	SCALING_PCLK_DELAY	0xA2	0x2A	

Table 2-2. Resolution Register Settings (Sheet 3 of 3)

Resolution	Register	Address	Value	Description (24 MHz Input Clock)
VGA	CLKRC	0x11	0x01	30 fps VGA Raw Bayer RGB mode
	COM7	0x12	0x01	
	COM3	0x0C	0x00	
	COM14	0x3E	0x00	
	SCALING_XSC	0x70	0x3A	
	SCALING_YSC	0x71	0x35	
	SCALING_DCWCTR	0x72	0x11	
	SCALING_PCLK_DIV	0x73	0xF0	
	SCALING_PCLK_DELAY	0xA2	0x02	
QVGA	CLKRC	0x11	0x01	30 fps QVGA Processed Bayer RGB mode
	COM7	0x12	0x11	
	COM3	0x0C	0x04	
	COM14	0x3E	0x1A	
	SCALING_XSC	0x70	0x3A	
	SCALING_YSC	0x71	0x35	
	SCALING_DCWCTR	0x72	0x11	
	SCALING_PCLK_DIV	0x73	0xF9	
	SCALING_PCLK_DELAY	0xA2	0x02	

3 Timing Generator

In general, the timing generator controls the following functions:

- [Array Control](#)
- [Frame Rate Timing](#)
- [Exposure Control](#)
- External timing outputs (VSYNC, HREF/HSYNC, PCLK, and STROBE)

3.1 Array Control

The OV7670/OV7171 CAMERACHIP progressively scans the array in which rows are sequentially read and transferred out to the Analog Processing Block (APB). The 'Raw Bayer RGB' and 'Processed Bayer RGB' output preserves the Bayer Filter pattern, so odd rows follow the pattern (BG) and even rows follow the pattern (GR). The sensor array always outputs VGA resolution and all resolutions below VGA are down-scaled from VGA in digital domain.

The scan direction is controlled by register [MVFP\[5:4\]](#) (0x1E) as shown in [Table 3-1](#).

Table 3-1. Scan Direction Control

Function	Register	Address	Description
Horizontal Mirror	MVFP[5]	0x1E	0: Normal 1: Mirrored
Vertical Flip	MVFP[4]	0x1E	0: Normal 1: Flipped

3.2 Frame Rate Timing

The OV7670/OV7171 offers three methods of frame rate adjustment:

- [Clock Pre-scalar](#)
- [Dummy Pixel Adjustment](#)
- [Dummy Row Adjustment](#)

3.2.1 Clock Pre-scalar

The OV7670/OV7171 CAMERACHIP pumps up the input clock by a PLL multiplier first, then divides the clock by Pre-scalar. The PLL multiplier is controlled by register [DBLV\[7:6\]](#) (0x6B) and the clock pre-scalar is set by register [CLKRC\[5:0\]](#) (0x11) as shown in [Table 3-2](#).

Table 3-2. Clock Pre-Scalar Control

Function	Register	Address	Description
PLL Multiplier	DBLV[7:6]	0x6B	00: Bypass PLL 01: PLL times the input clock by 4 10: PLL times the input clock by 6 11: PLL times the input clock by 8
Vertical Flip	CLKRC[5:0]	0x11	Clock Pre-scalar, the divider is $2 \times (\text{CLKRC}[5:0] + 1)$

The internal clock frequency, $f_{\text{INT CLK}}$, can be calculated from the input clock frequency, f_{CLK} , using the following equation:

$$f_{\text{INT CLK}} = f_{\text{CLK}} \times \text{PLL_Multiplier} / (2 \times (\text{CLKRC}[5:0] + 1))$$

The internal clock period, $t_{\text{INT CLK}}$, can be calculated from the input clock period, t_{CLK} , using the following equation:

$$t_{\text{INT CLK}} = t_{\text{CLK}} \times 2 \times (\text{CLKRC}[5:0] + 1) / \text{PLL_Multiplier}$$

The frame rate can be adjusted by the clock pre-scalar. [Table 3-3](#) gives the maximum frame rate, pixel clock rate of VGA resolution at a given input clock frequency and clock pre-scalar. When other resolutions are down-scaled from VGA, the frame rate is the same as VGA; however, the pixel clock rate (PCLK) is dependent on the scaling setting. When the pre-scalar changes, calculating the frame rate is straight forward based on [Table 3-3](#).

Table 3-3. VGA Frame Rate

Format	f_{CLK}	DBLV[7:6] (0x6B)	CLKRC[5:0] (0x11)	$f_{\text{INT CLK}}$	PCLK	Frame Rate
VGA YUV/YCbCr	24 MHz	1	1	24 MHz	24 MHz	30 fps
VGA Bayer RGB	24 MHz	1	1	24 MHz	12 MHz	30 fps

3.2.2 Dummy Pixel Adjustment

The OV7670/OV7171 CAMERACHIP can adjust the frame rate by inserting dummy pixels in the horizontal blanking period while leaving the pixel clock rate unchanged. The dummy pixel is inserted in the array output. Refer to [Table 3-4](#) for the details.

3.2.3 Dummy Row Adjustment

The OV7670/OV7171 CAMERACHIP can adjust the frame rate by inserting dummy rows while leaving the pixel rate and row interval unchanged. The dummy row is inserted in array output.

The dummy row can be manually inserted using registers {DM_LNH (0x93), DM_LNL (0x92)} or automatically inserted by the AEC. To insert dummy rows automatically, set register COM11[7] (0x3B) to 1 and limit the maximum number of dummy rows with register COM11[6:5] (0x3B). Refer to [Table 3-4](#) for details.

Table 3-4. Dummy Pixel and Row

Function	Register	Address	Description
Dummy Pixel	{EXHCH[7:4], EXHCL[7:0]}	{0x2A, 0x2B}	1 digital count is equal to 1/784 row period
Dummy Row	{DM_LNH[7:0], DM_LNL[7:0]}	{0x93, 0x92}	1 digital count is equal to 1/510 frame period
Dummy Row Position	DM_POS[7]	0x4D	0: Dummy row is inserted before active row 1: Dummy row is inserted after active row
Auto Frame Rate Adjustment (inserting dummy rows during VSYNC period)	COM11[7]	0x3B	0: Disable - set registers ADVFH (0x2E) and ADVFL (0x2D) to 0 1: Enable - the number of dummy rows are saved in registers ADVFH (0x2E) and ADVFL (0x2D). The number of dummy rows should be a multiple of N. See dummy row selection for N.
Auto Frame Rate Adjustment Range	COM11[6:5]	0x3B	00: Do not insert dummy row 01: Insert 0 or N dummy rows 10: Insert N or 3N dummy rows 11: Insert N or 3N or 7N dummy rows
Auto Frame Rate Adjustment Dummy Row Number Selection	NT_CTRL[3]	0xA4	0: N is equal to the maximum exposure time less than frame period which may be different from the number of rows per frame when banding filter is enabled 1: N is equal to the number of rows per frame
Auto Frame Rate Adjustment Switch Point	NT_CTRL[1:0]	0xA4	00: Insert dummy row at 2x gain 01: Insert dummy row at 4x gain 10: Insert dummy row at 8x gain 11: Insert dummy row at 16x gain

3.3 Exposure Control

The OV7670/OV7171 CAMERACHIP supports both automatic and manual exposure control modes. The exposure time is defined as the interval from the cell pre-charge to the end of the photo-induced current measurement and can be controlled manually or by using the AEC function. This exposure control uses a 'rolling' shutter, which means the exposure time is set on a row-by-row basis rather than on a frame-by-frame basis.

3.3.1 Exposure Time

Exposure time unit is the interval of row as shown below:

$$t_{\text{EXPOSURE}} = \text{AEC}[15:0] \times t_{\text{ROW INTERVAL}}$$

where AEC[15:0] is set by registers AECHH (0x07), AECH (0x10), and COM1[1:0] (0x04).

$$AEC[15:0] = \{AECHH[5:0] (0x07), AECH[7:0] (0x10), COM1[1:0] (0x04)\}$$

The OV7670/OV7171 array always outputs VGA resolution so the row interval is:

$$t_{ROW\ INTERVAL} = 2 \times (784 + \text{Dummy Pixels}) \times t_{INT\ CLK}$$

and AEC[15:0] is limited by the number of rows of VGA resolution plus the number of dummy rows.

3.3.2 Banding Filter

In 50 or 60 Hz flicker light, the exposure time must be a multiple of the flicker interval to avoid banding shown on the image. For 50Hz light, the exposure time must be:

$$t_{EXPOSURE} = N / 100$$

and for 60 Hz light, the exposure must be:

$$t_{EXPOSURE} = N / 120$$

where N is a positive integer.

Since the exposure time AEC[15:0] is based on row interval, AEC needs to know 1/100 second and 1/120 second is equal to how many rows. Banding filter registers, [BD50ST\(0x9D\)](#) and [BD60ST\(0x9E\)](#), are used to set 1/100 and 1/120 second. The banding filter can be calculated by:

$$\text{Banding Filter Value} = 1 / (120 \times t_{ROW\ INTERVAL}) = \frac{\text{Frame Rate} \times \text{Maximum Exposure}}{120} \quad \text{for 60 Hz}$$

$$\text{Banding Filter Value} = 1 / (100 \times t_{ROW\ INTERVAL}) = \frac{\text{Frame Rate} \times \text{Maximum Exposure}}{100} \quad \text{for 50 Hz}$$

where Maximum Exposure is equal to the number of rows per frame plus the number of dummy rows minus 2.

The OV7670/OV7171 CAMERACHIP can also disable the banding filter to allow any exposure time value. When the banding filter is enabled, the OV7670/OV7171 also allows the exposure time less than 1/120 or 1/100 second in strong light conditions by setting register [COM11\[1\] \(0x3B\)](#) to 1.

[Table 3-5](#) summarizes the registers used to control exposure time and how to set the banding filter.

Table 3-5. Exposure and Banding Filter (Sheet 1 of 2)

Function	Register	Address	Description
Exposure Time	{ AECHH[5:0] , AECH[7:0] , COM1[1:0] }	{0x07, 0x10, 0x04}	Unit is $t_{ROW\ INTERVAL}$
Banding Filter Enable	COM8[5]	0x13	0: Disable banding filter - the exposure time can be any number 1: Enable banding filter - the exposure time must be N/100 or N/120 second.

Table 3-5. Exposure and Banding Filter (Sheet 2 of 2)

Function	Register	Address	Description
Banding Filter for 50 Hz	BD50ST	0x9D	
Banding Filter for 60 Hz	BD60ST[7]	0x9E	
Banding Filter Selection	COM11[4:3]	0x3B	00: Select the value of register BD60ST (0x9E) 01: Select the value of register BD60ST (0x9E) 1x: Banding filter is selected based on 50/60 Hz auto detection
Exposure time less than 1/100 or 1/120	COM11[1]	0x3B	0: Limit the minimum exposure time to 1/100 or 1/120 second in any light condition when banding filter is enabled 1: Allow exposure time to be less than 1/100 or 1/120 second in strong light condition when banding filter is enabled

3.3.2.1 Automatic 50/60 Hz Banding Detection

The OV7670/OV7171 CAMERACHIP supports automatic 50/60Hz banding detection function, where the OV7670/OV7171 detects light frequency and automatically adjusts the exposure time.

Please contact your local OmniVision FAE for automatic 50/60 Hz banding detection settings.

3.3.3 Manual Exposure Control

The OV7670/OV7171 CAMERACHIP works in manual exposure mode when register [COM8](#)[0] (0x13) is low. In manual exposure control mode, the companion backend processor can fully control the OV7670/OV7171 exposure time. The companion backend processor may write exposure values to [AEC](#)[15:0] according to its corresponding Automatic Exposure Control (AEC) algorithm.

The companion backend processor also must set the correct exposure time to avoid banding in flickering light. Refer to [Section 3.3.1](#) and [Section 3.3.2](#) for the exposure time calculation.

3.3.4 Automatic Exposure Control Mode (AEC)

The AEC function allows for the CAMERACHIP to adjust the exposure without external command or control. The OV7670/OV7171 CAMERACHIP supports two different AEC algorithms, Histogram-based and Average-based, as shown in [Table 3-6](#). Note that both AEC and AGC functions are controlled by the same algorithm and share the registers that control the algorithm parameters. In general, the AEC is the primary control and will be adjusted before the AGC (AGC acts to adjust and center the AEC).

Table 3-6. Exposure Control Mode

Function	Register	Address	Description
AEC Enable	COM8[0]	0x13	0: Disable AEC 1: Enable AEC
AEC Speed	COM8[7]	0x13	0: Normal speed 1: Fast speed
AEC Algorithm Selection	NALG[7]	0xAA	0: Average-based AEC algorithm 1: Histogram-based AEC algorithm

Both histogram-based AEC/AGC and average-based AEC/AGC define the fast operating region in which the AEC/AGC adjusts the image luminance very fast by increasing the exposure time and gain adjustment.

3.3.4.1 Average-based AEC/AGC

As shown in Figure 3-1, the average-based AEC/AGC algorithm changes the luminance average value step by step until it converges with Stable Operating Region. Outside the Control Zone, the AEC/AGC adjusts exposure time and gain in large steps to change the luminance level fast. Once inside the Control Zone but still outside the Stable Operating range, the AEC/AGC adjusts exposure time and gain in smaller steps to make the luminance level converge with the Stable Operating Region smoothly. When finally inside the Stable Operating Region, the AEC/AGC no longer adjusts the exposure time and gain. Table 3-7 summarizes the control registers of average based AEC/AGC.

Figure 3-1 Average-based AEC/AGC

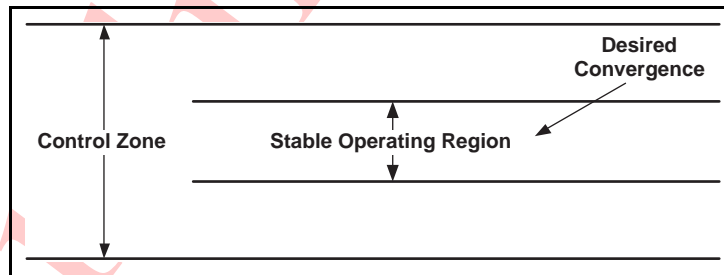

Table 3-7. Average-based AEC/AGC Registers

AEC/AGC Algorithm Selection	Register	Address	Description
Stable Operating Region – Upper Limit	AEW[7:0]	0x24	
Stable Operating Region – Lower Limit	AEB[7:0]	0x25	
Control Zone – Upper Limit high nibble	VPT[7:4]	0x26	Upper limit is {VPT[7:4], 4'h0}
Control Zone – Lower Limit high nibble	VPT[3:0]	0x26	Lower limit is {VPT[3:0], 4'h0}
Average luminance calculation window (effective for both average and histogram-based AEC/AGC)	COM4[5:4]	0x0D	00: Full frame 01: Center half frame 1x: Center quarter frame

3.3.4.2 Histogram-based AEC/AGC

As shown in Figure 3-2, histogram-based AEC/AGC algorithm adjusts the luminance histogram of step by step until the desired distribution is reached. The probability of luminance level l , $p(l)$, is defined as the normalized percentage of the pixel count with luminance $l_0 \leq l$, i.e.,

$$p(l) = 255 \times \text{Pixel count with luminance } l_0 \leq l / \text{Total pixel count}$$

Figure 3-2 Histogram-Based AEC Control

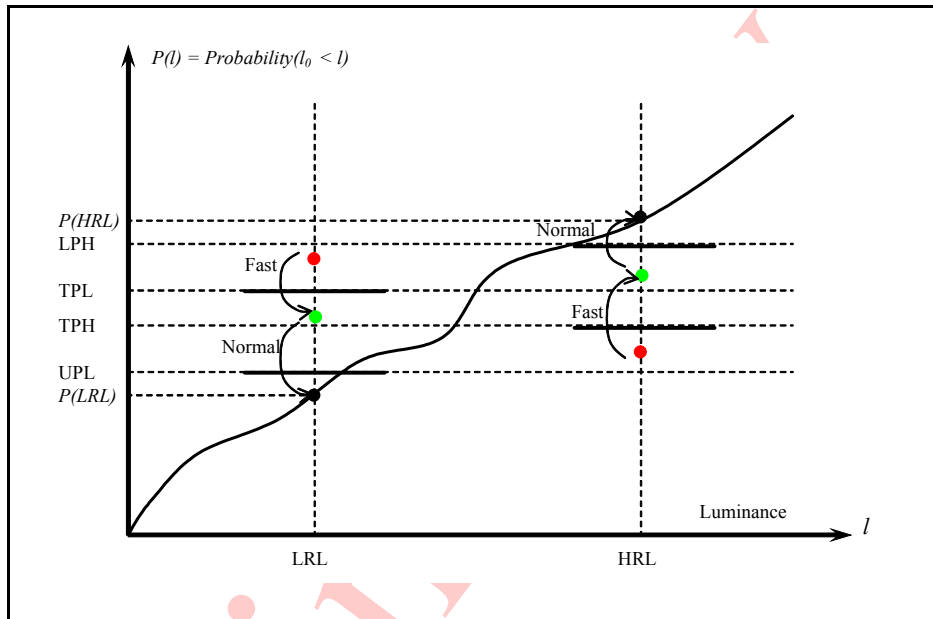

Table 3-8. Histogram-based AEC Related Registers

Function	Register	Address
LRL – Low Reference Luminance	LRL[7:0]	0xA0
HRL – High Reference Luminance	HRL[7:0]	0x9F
LPH – Lower Limit of Probability for HRL, after exposure/gain stabilizes	LPH[7:0]	0xA6
UPL – Upper Limit of Probability for LRL, after exposure/gain stabilizes	UPL[7:0]	0xA7
TPL – Probability Threshold for LRL to control AEC/AGC speed	TPL[7:0]	0xA8
TPH – Probability Threshold for HRL to control AEC/AGC speed	TPH[7:0]	0xA9
TLH – High nibble of Luminance High Threshold for AEC/AGC speed control If $p(LRL)$ is greater than TPL and the average luminance is less than $16 \times TLL$, AEC/AGC increases luminance at fast speed; otherwise, AEC/AGC works at normal speed. The average luminance is the same as average-based AEC/AGC.	AEW[7:4]	0x24
TLL – High nibble of Luminance Low Threshold for AEC/AGC speed control If $p(HRL)$ is less than TPH and the average luminance is greater than $16 \times TLH$, AEC/AGC reduces luminance at fast speed; otherwise, AEC/AGC works at normal speed. The average luminance is the same as average based AEC/AGC.	AEB[7:4]	0x25

Table 3-9 lists all the registers that control the Histogram-based AEC adjustments.

Table 3-9. Histogram-based AEC Algorithm Adjustment Controls

Control	Selection	Registers
Luminance Saturation Control	More saturated	Decrease both LPH (0xA6) and UPL (0xA7) values
	Less saturated	Increase both LPH (0xA6) and UPL (0xA7) values
Image Brightness Control	Brighter image	Increase both LRL (0xA0) and HRL (0x9F) values
	Darker image	Decrease both LRL (0xA0) and HRL (0x9F) values
AEC Speed Controlled by TLH and TLL	Higher speed	Decrease TLH (AEW [7:4] (0x24)) but not less than target image luminance and increase TLL (AEB [7:4] (0x25)) but not bigger than target luminance. TLH should be bigger than 1.2x target image luminance and TLL should be less than 0.8x target image luminance.
	Lower speed	Increase TLH (AEW [7:4] (0x24)) and decrease TLL (AEB [7:4] (0x25))
AEC Speed Controlled by TPL and TPH	Higher speed	Decrease TPL (0xA8) but not less than UPL and increase TPH (0xA9) but not bigger than LPH
	Lower speed	Increase TPL (0xA8) and decrease TPH (0xA9)
AEC Flickering versus LRL and HRL	<p>HRL should be bigger than LRL</p> <p>The relationship between these two values is shown below: $\mathbf{HRL} \geq 1.07 \times \mathbf{LRL}$</p>	
AEC Flickering versus LPH and UPL	<p>LPH should be bigger than UPL</p> <p>If the difference (LPH - UPL) is big, AEC flickering can occur. The recommended relationship between these two values is shown below: $\mathbf{LPH} \leq 1.07 \times \mathbf{UPL}$</p>	

3.4 External Timing Output

3.4.1 Sync Signal

The OV7670/OV7171 CAMERACHIP supplies two output sync signals: VSYNC and HREF. The vertical sync signal (VSYNC) is output from pin D1. The horizontal reference signal (HREF) is output from pin D2. The HSYNC signal is available on pin D2 (shares with HREF) when register [COM10](#)[6] (0x15) is set to '1'.

VSYNC and HSYNC signals are continuous. The HREF signal is only valid when there is output data. If there is no output data, the HREF signal will remain at either high or low, depending on the polarity selection. VSYNC, HSYNC, HREF and PCLK polarity are controlled by register [COM10](#)[1] (0x15), [COM10](#)[0], [COM10](#)[3] and [COM10](#)[4], respectively. Usually, the application uses the rising edge of PCLK to capture data when HREF is high.

PCLK signal is free running by default. Setting register [COM10](#)[5] (0x15) to high gates PCLK by HREF.

The OV7670/OV7171 CAMERACHIP also supports CCIR656 format. Instead of using HREF to define each row, the ITU-656 standard inserts a 4-byte header before and after the row data.

Header Footer: [FF] [00] [00] [Sync Byte]

Setting register [COM1](#)[6] (0x04) high turns on CCIR656 format. OmniVision suggests using the output range control register [COM15](#)[7:6] (0x40) to limit image data range so that the image data does not contain 0x00 and 0xFF.

[Table 3-10](#) summarizes the registers related to the sync signal.

Table 3-10. Sync Signal Related Registers

Function	Register	Address	Description
HSYNC/VSYNC Polarity	COM10 [1:0]	0x15	1: Negative
HREF Polarity	COM10 [3]	0x15	1: Negative
Pixel Delay Select	PSHFT [7:0]	0x1B	
PCLK Reference Edge	COM10 [4]	0x15	0: Data update at falling edge 1: Data update at rising edge
ITU-656 Format Enable	COM1 [6]	0x04	1: Enable
Output Full Range Enable	COM15 [7:6]	0x40	00: 0x10 to 0xF0 01: 0x10 to 0xF0 10: 0x01 to 0xFE 11: 0x00 to 0xFF
Output HSYNC on HREF Pin Enable	COM10 [6]	0x15	0: HREF 1: HSYNC
PCLK Output Gated by HREF Enable	COM10 [6]	0x15	0: Free running PCLK 1: PCLK gated by HREF
HSYNC Rising Edge Delay	MSB: EXHCH [1:0] LSB: HSYST [7:0]	0x2A 0x30	
HSYNC Rising Edge Delay	MSB: EXHCH [3:2] LSB: HSYEN [7:0]	0x2A 0x31	

3.4.2 Strobe Signal

To achieve the best image quality possible in low light conditions, the use of a strobe flash is recommended. To avoid the need for a mechanical shutter and release the loading of a backend companion processor, the OV7670/OV7171 CAMERACHIP provides a strobe signal, which is synchronized with the internal rolling shutter, to control the external flashlight.

The strobe signal is programmable. It supports both LED and Xenon mode. The polarity of the pulse is adjustable. The strobe signal is initiated (turned high/low depending on the pulse's polarity) by setting register [STR-OPT\[7\]](#) (0xAC) to 1. To exit strobe mode, set register [STR-OPT\[7\]](#) (0xAC) to 0. Flash modules are typically triggered to the rising edge (falling edge, if signal polarity is changed). It supports following flashlight modes.

Table 3-11. Flashlight Modes

Function	Register	Address	Description
Flashlight Mode Select	STR-OPT[1:0]	0xAC	00: Xenon mode 01: LED 1 1x: LED 2
Strobe Request	STR-OPT[7]	0xAC	0: Exit strobe mode 1: Enter strobe mode
Color Gain Control Enable	STR-OPT[6]	0xAC	0: Disable 1: Enable
Red Gain in Flashlight Mode	STR_R	0xAD	
Green Gain in Flashlight Mode	STR_G	0xAE	
Blue Gain in Flashlight Mode	STR_B	0xAF	
Strobe Signal Polarity Control	STR-OPT[2]	0xAC	0: Active high 1: Active low

In flashlight mode, to adjust the exposure and gain, the backend processor can turn OFF AEC/AGC by setting registers [COM8\[2\]](#) and [COM8\[0\]](#) (0x13) to 0. To adjust the color gain, the backend processor can set register [STR-OPT\[6\]](#) (0xAC) to 1 and set the color gain with registers [STR_R](#) (0xAD), [STR_G](#) (0xAE), and [STR_B](#) (0xAF). After exiting from flashlight mode, AEC/AGC will start from these new values.

3.4.2.1 Xenon Flash Control

After a strobe request is submitted, the strobe pulse will be activated at the beginning of the third frame. The third frame will be correctly exposed. The pulse width is programmable from $1T_{row}$ to $4T_{row}$, where T_{row} is the row period (see Table 3-12). Figure 3-3 shows the timing.

Figure 3-3 Xenon Flash Mode

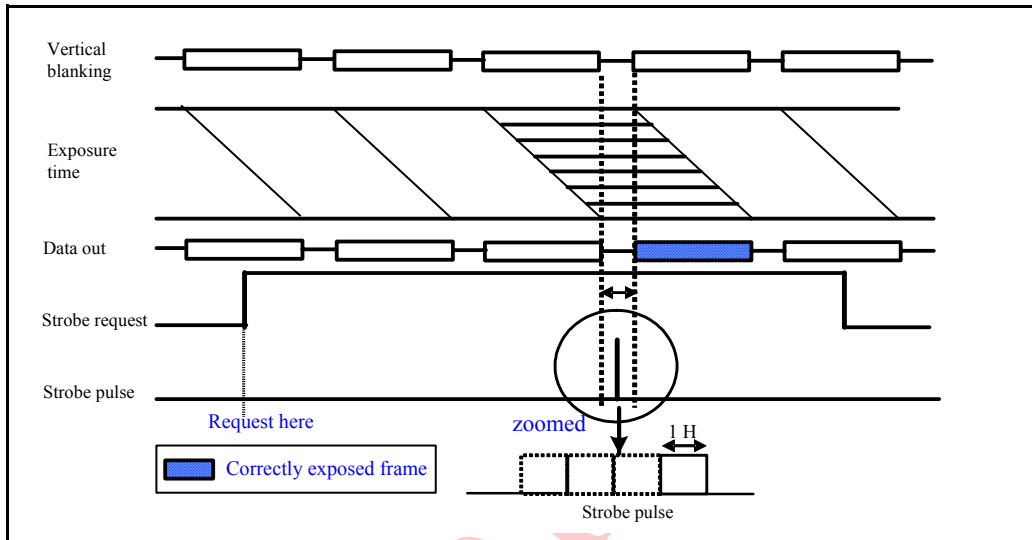

Table 3-12. Xenon Flash Pulse Width Control

Function	Register	Address	Description
Xenon Flash Pulse Width	STR-OPT[5:4]	0xAC	00: 1 row 01: 2 rows 10: 3 rows 11: 4 rows

3.4.2.2 LED 1 Mode

Two frames after the strobe request is submitted, the third frame is correctly exposed. The strobe pulse will be activated only one time if the strobe end request is set correctly (see Figure 3-4). If the end request is not sent, the strobe signal is activated intermittently until the strobe end request is set (see Figure 3-5). The number of skipped frames is programmable.

Figure 3-4 LED 1 Mode – One Pulse Output

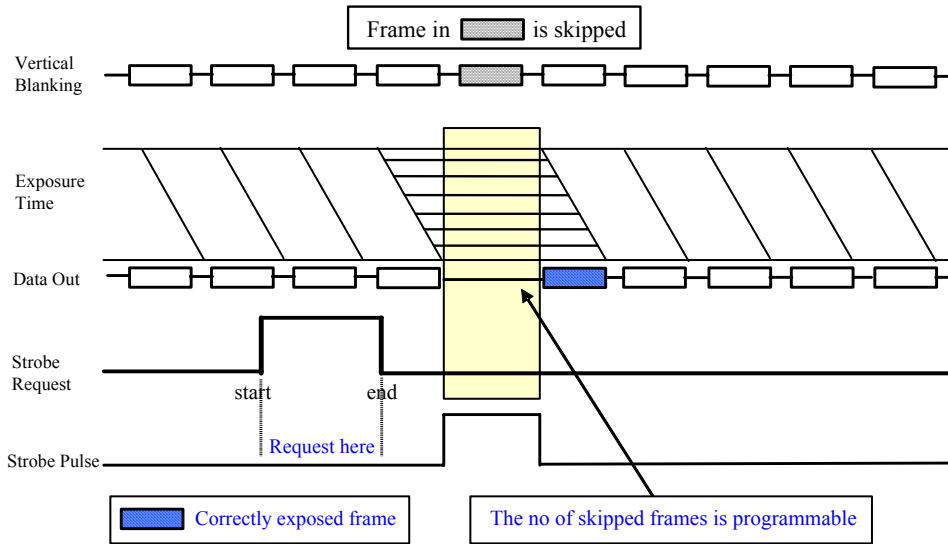
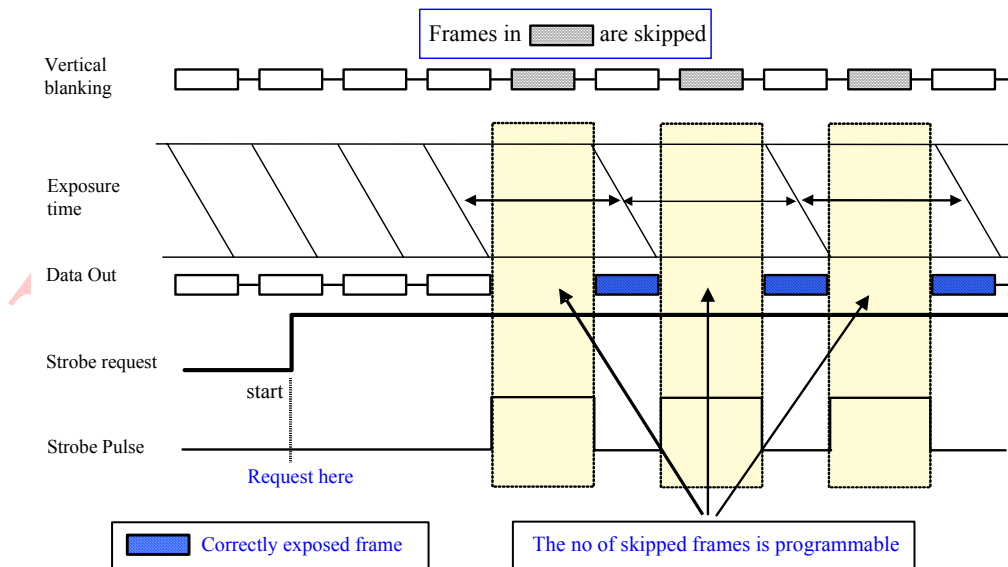

Figure 3-5 LED 1 Mode – Multiple Pulse Output



3.4.2.3 LED 2 Mode

In LED 2 mode, the strobe signal stays active until the strobe end request is sent (see Figure 3-5).

Figure 3-6 LED 2 Mode

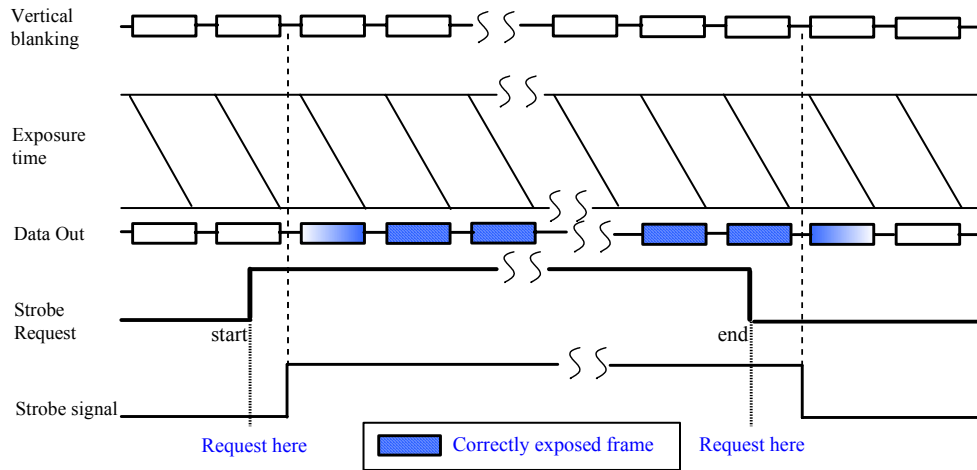

Preliminary

4 Analog Signal Processor

This block performs all analog image functions including gain control, black level calibration, and other image manipulation functions

4.1 Gain Control

The OV7670/OV7171 CAMERACHIP provides support for both Automatic Gain Control (AGC) and manual gain control modes.

4.1.1 Manual Gain Control

The manual gain control mode allows for the companion backend processor to control the OV7670/OV7171 gain value. The companion backend processor can write gain values to register `GAIN[7:0]` (0x00) and `VREF[7:6]` (0x03) according to its gain control algorithm. The formula to calculate the gain from register value is:

$$\text{Gain} = (\text{VREF}[7]+1) \times (\text{VREF}[6]+1) \times (\text{GAIN}[7]+1) \times (\text{GAIN}[6]+1) \times (\text{GAIN}[5]+1) \times (\text{GAIN}[4]+1) \times (\text{GAIN}[3:0]/16 + 1)$$

The gain to register value correlation is shown in [Table 4-1](#).

Table 4-1. Total Gain to Control Bit Correlation

Registers VREF[7:6] (0x03), GAIN[7:0] (0x00)	Gain	dB
00 00000000	1	0
00 00000001	1 + 1/16	.375
00 00000010	1 + 2/16	.75
00 00000011	1 + 3/16	1.125
00 00000100	1 + 4/16	1.5
00 00000101	1 + 5/16	1.875
00 00000110	1 + 6/16	2.25
00 00000111	1 + 7/16	2.625
00 00001000	1 + 8/16	3
00 00001001	1 + 9/16	3.375
00 00001010	1 + 10/16	3.75
00 00001011	1 + 11/16	4.125
00 00001100	1 + 12/16	4.5
00 00001101	1 + 13/16	4.875
00 00001110	1 + 14/16	5.25
00 00001111	1 + 15/16	5.625
00 00010000	2 × (1 + 0/16)	6
00 00110000	4 × (1 + 0/16)	12
00 01110000	8 × (1 + 0/16)	18
00 11110000	16 × (1 + 0/16)	24
01 11110000	32 × (1 + 0/16)	30
11 11110000	64 × (1 + 0/16)	36
11 11111111	64 × (1 + 15/16)	~42

Note: To achieve the best image quality, using "maximum" exposure and "minimum" gain for the highest S/N ratio is recommended. When operating in low-light condition, use the strobe flash.

4.1.2 Automatic Gain Control (AGC)

The AGC function allows the OV7670/OV7171 CAMERACHIP to adjust image luminance by changing gain without external command or control. Register setting **COM8[2]** (0x13) enables or disables the AGC function. When the AGC function is enabled, gain is automatically adjusted and the result is saved in register {**VREF[7:6]** (0x03), **GAIN[7:0]** (0x00)}. The maximum gain is limited by the gain ceiling (see [Table 4-2](#)). When AGC function is disabled, the gain control is still active and the user can change the gain setting.

The AGC uses the same algorithm as the AEC and shares most of the control registers with the AEC. [Table 4-2](#) summarizes the general controls for the AGC. To achieve the best image quality, the sensor should always increase exposure time prior to gain and reduce gain prior to exposure time.

Table 4-2. AGC General Controls

Function	Register	Address	Description
AGC Enable	COM8[2]	0x13	0: Disable AGC function, gain control function is still active 1: Enable AGC function
Gain Setting	VREF[7:6] GAIN[7:0]	0x03 0x00	Gain setting. Read-only when AGC is enabled. When AGC is disabled, these registers can be programmed manually.
Gain Ceiling Select	COM9[6:4]	0x14	Sets the upper limit of the gain value 000: 2x 001: 4x 010: 8x 011: 16x 100: 32x 101: 64x 110: 128x 111: 128x

4.2 Black Level Calibration

Black Level Calibration (BLC) compensates for the dark current induced by temperature and exposure changes. BLC can work in manual or automatic mode.

4.2.1 Automatic Black Level Calibration (ABLC)

The OV7670/OV7171 CAMERACHIP uses the true optical black pixel for Automatic Black Level Calibration (ABLC). Setting register [ABLC1](#)[3] (0xB1) to 1 turns on the ABLC function. ABLC adjusts the black level compensation for each channel so that the black level is within the stable range set by registers [THL_ST](#) (0xB3) and [THL_DLT](#) (0xB5). [Table 4-3](#) lists the ABLC control registers.

Table 4-3. ABLC Control Registers

Function	Register	Address	Description
ABLC Enable	ABLC1 [2]	0xB1	0: Disable ABLC function, BLC function is still active 1: Enable ABLC function
Lower Limit of Black Level + 0x80	THL_ST	0xB3	
Stable Range of Black Level	THL_DLT	0xB5	The upper limit of black level is: THL_ST (0xB3) + THL_DLT (0xB5) + 0x80
Blue Channel Black Level Compensation	AD-CHB [6:0]	0xBE	AD-CHB [6] is the sign bit where 0 means addition and 1 means subtraction.
Red Channel Black Level Compensation	AD-CHR [6:0]	0xBF	AD-CHR [6] is the sign bit where 0 means addition and 1 means subtraction.
Gb Channel Black Level Compensation	AD-CHGb [6:0]	0xC0	AD-CHGb [6] is the sign bit where 0 means addition and 1 means subtraction.
Gr Channel Black Level Compensation	AD-CHGr [6:0]	0xC1	AD-CHGr [6] is the sign bit where 0 means addition and 1 means subtraction.

4.2.2 Manual Black Level Calibration

The black level compensation, registers [AD-CHB](#) (0xBE) to [AD-CHGr](#) (0xC1), can be also adjusted for manual black level calibration. To do this, disable the ABLC function first.

5 Digital Signal Processor (DSP)

The following subsections describe the controls for white balance, gamma, color matrix, sharpness, de-noise, defect pixel correction, and other functions controlled by the Digital Signal Processor (DSP).

5.1 White Balance Control

The OV7670/OV7171 CAMERACHIP supports the automatic white balance (AWB) function. The AWB circuit automatically adjusts red, green, and blue gain to make the white target be white regardless of the lighting. The OV7670/OV7171 builds two AWB algorithms - normal AWB and advanced AWB. Normal AWB makes the average of red, green and blue equal. Advanced AWB detects the color temperature of the light and adjusts the color gain based on the color temperature. When AWB function is disabled, the user can also manually adjust red, green and blue gain to make the image white balanced. The following is a summary of the three White Balance modes.

- Manual mode – Red, Green, and Blue gain are set manually
- Normal AWB mode – Red, green, and blue gain are controlled by the AWB circuit. The AWB circuit adjusts the gain to make red, green, and blue average values equal
- Advanced AWB mode – Red, green, and blue gain are controlled by the AWB circuit. The AWB circuit adjusts the gain based on color temperature.

In addition to the color gain that is controlled by the AWB circuit or the user, the OV7670/OV7171 also supports pre-gain for each color channel. [Table 5-1](#) lists the common control registers used for white balance.

Table 5-1. White Balance Control Registers

Function	Register	Address	Description
AWB Enable	COM8[1]	0x13	0: Disable AWB, White Balance is in manual mode 1: Enable AWB, White Balance is in auto mode
AWB Mode Select	AWBCTR0[0]	0x6F	0: Advanced AWB mode 1: Normal AWB mode
AWB Adjustment Control	AWBCTR0[3]	0x6F	0: AWB adjusts R and B gain only 1: AWB adjusts R, G, and B gain
Maximum Color Gain	AWBCTR0[2]	0x6F	0: Maximum color gain is 2x 1: Maximum color gain is 4x
AWB Gain Enable	COM16[3]	0x41	0: Bypass AWB gain 1: Enable AWB gain
Blue Channel Gain	BLUE[7:0]	0x01	
Red Channel Gain	RED[7:0]	0x02	
Green Channel Gain	GGAIN[6:0]	0x6A	Both Gr and Gb
AWB B Gain Range	B_LMT	0x5F	{{(B_LMT[7:4], 4'hF), (4'h0, B_LMT[3:0])}}

Table 5-1. White Balance Control Registers

Function	Register	Address	Description
AWB R Gain Range	R_LMT	0x60	{{R_LMT[7:4], 4'hF}, (4'h0, R_LMT[3:0])}
AWB G Gain Range	G_LMT	0x61	{{G_LMT[7:4], 4'hF}, (4'h0, G_LMT[3:0])}
AWB Pre-Gain Gr channel pre-gain Gb channel pre-gain Red channel pre-gain Blue channel pre-gain	GFIX[7:6] GFIX[5:4] GFIX[3:2] GFIX[1:0]	0x69	00: 1x 01: 1.25x 10: 1.5x 11: 1.75x

5.1.1 Automatic White Balance Control

Table 5-2 lists the control registers for the Automatic White Balance function.

Table 5-2. AWB Control Registers

Function	Register	Address	Description
Advanced AWB Control Parameters	AWBC1 to AWBC6, AWBC7 to AWBC12	0x43 to 0x48, 0x59 to 0x5E	These parameters depend on the lens. Contact your local OmniVision FAE for these AWB settings.
???	AWBCTR1	0x6E	

5.1.2 Manual White Balance

In manual mode, the companion backend processor can control the OV7670/OV7171 internal Red, Green, and Blue register values to achieve white balance. The gain is calculated using the equation shown below:

$$\text{Gain} = \text{Register Value} / 0x40 \quad \text{when the maximum gain is set to 4x}$$

or

$$\text{Gain} = \text{Register Value} / 0x80 \quad \text{when the maximum gain is set to 2x}$$

The gain is digital gain so always set the minimum gain of the three channels to 1x and do not apply less than 1x gain to any channel.

5.2 Gamma Control

The OV7670/OV7171 gamma curve is composed of approximately 16 linear lines as shown in Figure 5-1 and Table 5-3.

Figure 5-1 Gamma Curve

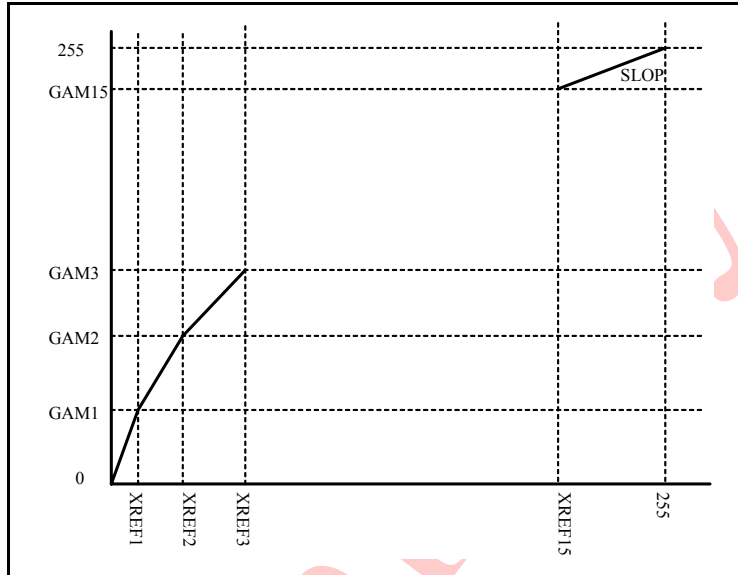

Table 5-3. Gamma Related Registers and Parameters

Gamma Segments Start Point		Gamma Segments Horizontal Reference	
Name	Register	Name	Value
GAM1	0x7B	XREF1	4
GAM2	0x7C	XREF2	8
GAM3	0x7D	XREF3	16
GAM4	0x7E	XREF4	32
GAM5	0x7F	XREF5	40
GAM6	0x80	XREF6	48
GAM7	0x81	XREF7	56
GAM8	0x82	XREF8	64
GAM9	0x83	XREF9	72
GAM10	0x84	XREF10	80
GAM11	0x85	XREF11	96
GAM12	0x86	XREF12	112
GAM13	0x87	XREF13	144
GAM14	0x88	XREF14	176
GAM15	0x89	XREF15	208
SLOP	0x7A	SLOP = (256 - GAM15) x 40/30	

5.2.1 Gamma Slope Calculation

Gamma control also needs the slope of the 16th segment (register **SLOP** (0x7A)), which can be calculated by the following equation:

$$\text{SLOP} = (255 - \text{GAM15} + 1) \times 40/30$$

5.3 Color Matrix

The color matrix is used to eliminate the cross talk induced by the micro-lens and color filter process. It also compensates for lighting and temperature effects. Hue, color saturation, color space conversion from RGB to YUV/YCbCr can also be controlled by the color matrix.

5.3.1 Color Matrix Control

The OV7670/OV7171 has a 3x3 color matrix circuit inside. This color matrix performs color correction and RGB to YUV/YCbCr conversion. Also, because of the Matrix linear algebra characteristic, it can also do color saturation and hue control as shown below:

The OV7670/OV7171 CAMERACHIP matrix circuit is active in YUV/YCbCr and other formats derived from YUV/YCrCb are shown below:

$$\begin{bmatrix} V \\ U \end{bmatrix} \text{ or } \begin{bmatrix} Cr \\ Cb \end{bmatrix} = \text{ColorMatrix} \begin{bmatrix} R \\ G \\ B \end{bmatrix}$$

$$\text{where ColorMatrix} = \begin{bmatrix} \text{MTX1} & \text{MTX2} & \text{MTX3} \\ \text{MTX4} & \text{MTX5} & \text{MTX6} \end{bmatrix}$$

The Y signal is not from color matrix. The sensor generates the Y signal from the original RGB directly. The color matrix performs the color correction, RGB to YUV/YCbCr conversion, hue and color saturation control. Though the Y signal is not from the color matrix, the calculation should be done by 3x3 matrix to get the combined matrix as shown below:

CombinedMatrix = SaturationMatrix x HueMatrix x ConversionMatrix x CorrectionMatrix

and then take the two rows for UV/CbCr as the final color matrix.

[Table 5-4](#) lists all the color matrix related registers. Each matrix element has 9 bits, 1 sign bit and 8 data bits. The register value equals up to 128 times the real color matrix value.

Table 5-4. Color Matrix Related Registers and Parameters

Name	Register	Address	Reset Value
MTX1	MTX1	0x4F	0x40
MTX2	MTX2	0x50	0x34
MTX3	MTX3	0x51	0x0C
MTX4	MTX4	0x52	0x17
MTX5	MTX5	0x53	0x29
MTX6	MTX6	0x54	0x40
Sign Bit	MTXS[5:0] - for MTX6 through MTX1, respectively	0x58	0x1E
MTX Doubler	COM16[1] 0: Directly use color Matrix 1: Double color Matrix	0x41	0

5.3.1.1 Color Correction Matrix

Below is the recommended color correction matrix for the OV7670/OV7171:

$$\begin{bmatrix} R_0 \\ G_0 \\ B_0 \end{bmatrix} = \begin{bmatrix} 1.36 & -0.3 & -0.06 \\ -0.20 & 1.32 & -0.12 \\ -0.04 & -0.55 & 1.59 \end{bmatrix} \times \begin{bmatrix} R \\ G \\ B \end{bmatrix}$$

5.3.1.2 RGB to YUV Conversion Matrix

The color conversion matrix can be derived from the standard equations below:

$$Y = 0.59G + 0.31R + 0.11B$$

$$U = B - Y$$

$$V = R - Y$$

$$Cr = 0.713 (R - Y)$$

$$Cb = 0.563 (B - Y)$$

5.3.1.3 Hue Control

Below is the hue matrix for α :

$$\begin{bmatrix} Y \\ U \text{ or } Cb \\ V \text{ or } Cr \end{bmatrix} = \begin{bmatrix} 1 & 0 & 0 \\ 0 & \cos \alpha & -\sin \alpha \\ 0 & \sin \alpha & \cos \alpha \end{bmatrix} \times \begin{bmatrix} Y \\ U_0 \text{ or } Cb_0 \\ V_0 \text{ or } Cr_0 \end{bmatrix}$$

5.3.1.4 Color Saturation

$$\begin{bmatrix} Y \\ U \text{ or } Cb \\ V \text{ or } Cr \end{bmatrix} = \begin{bmatrix} 1 & 0 & 0 \\ 0 & \text{gain} & 0 \\ 0 & 0 & \text{gain} \end{bmatrix} \times \begin{bmatrix} Y \\ U_0 \text{ or } Cb_0 \\ V_0 \text{ or } Cr_0 \end{bmatrix}$$

5.4 Sharpness Control

The OV7670/OV7171 CAMERACHIP sharpness control enhances the sharpness of YUV/YCbCr or derived format. The sharpness function works in automatic or manual mode, depending on register [COM16\[5\]](#) (0x41). In automatic mode, sharpness changes with the gain (the higher the gain, the lower the sharpness). In automatic mode, the upper limit of sharpness is set by register [REG75\[4:0\]](#) (0x75) and the lower limit is set by register [REG76\[4:0\]](#) (0x76). [Table 5-5](#) lists the sharpness related registers.

Table 5-5. Sharpness Control Registers

Function	Register	Address	Description
Sharpness Mode Select	COM16[5]	0x41	0: Manual mode, sharpness is set by register EDGE (0x3F) 1: Automatic mode, sharpness is adjusted automatically and saved in register EDGE (0x3F)
Sharpness	EDGE[4:0]	0x3F	In auto mode, this register is updated automatically. In manual mode, this register is set by the user.
Lower Limit of Sharpness	REG76[4:0]	0x76	Effective in automatic mode
Upper Limit of Sharpness	REG75[4:0]	0x75	Effective in automatic mode

5.5 De-Noise

The OV7670/OV7171 CAMERACHIP has a built-in de-noise function to reduce noise level. The de-noise function works in automatic or manual mode, depending on register [COM16\[4\]](#) (0x41). In automatic mode, the de-noise strength changes with the gain (the higher the gain, the stronger the de-noise). In automatic mode, the offset of the de-noise strength is set by register [REG77](#) (0x77). [Table 5-6](#) lists de-noise related registers.

The de-noise function works in of YUV/YCbCr or derived format, and processed Bayer RGB format.

Table 5-6. De-Noise Related Registers and Parameters

Function	Register	Address	Description
De-noise Mode Selection	COM16[4]	0x41	0: Manual mode, de-noise strength is set by register DNSTH (0x4C) 1: Automatic mode, de-noise strength is adjusted automatically and saved in register DNSTH (0x4C)
De-noise Threshold	DNSTH[7:0]	0x4C	In automatic mode, this register is updated automatically. In manual mode, this register is set by the user
De-noise Offset	REG77[7:0]	0x77	Effective in automatic mode

5.6 Auto Color Saturation Adjustment

The OV7670/OV7171 CAMERACHIP can automatically adjust color saturation based on gain (the higher the gain, the weaker the color). [Table 5-7](#) lists the auto color saturation adjustment related registers.

Table 5-7. Auto Color Saturation Adjustment Related Registers

Function	Register	Address
Color Saturation Lower Limit	SATCTR[7:4]	0xC9
Current Color Saturation Level	SATCTR[3:0]	0xC9

5.7 Defect Pixel Correction

The OV7670/OV7171 CAMERACHIP has a built-in white and black defect pixel correction circuit to correct white and black pixels. Setting register [REG76](#)[6:5] (0x76) will enable the white and black pixel correction function.

5.8 Lens Correction

Due to the lens roll off, the pixels along the edge and corner areas receive much less light than the pixels in the center area, resulting in an image that is darker at the edges and corner areas. The lens correction function amplifies pixel output based on the distance from the pixel to the lens' optical center to achieve a uniform image. [Figure 5-2](#) shows the lens correction of the OV7670/OV7171 CAMERACHIP and [Table 5-8](#) lists lens correction related registers.

Figure 5-2 Lens Correction

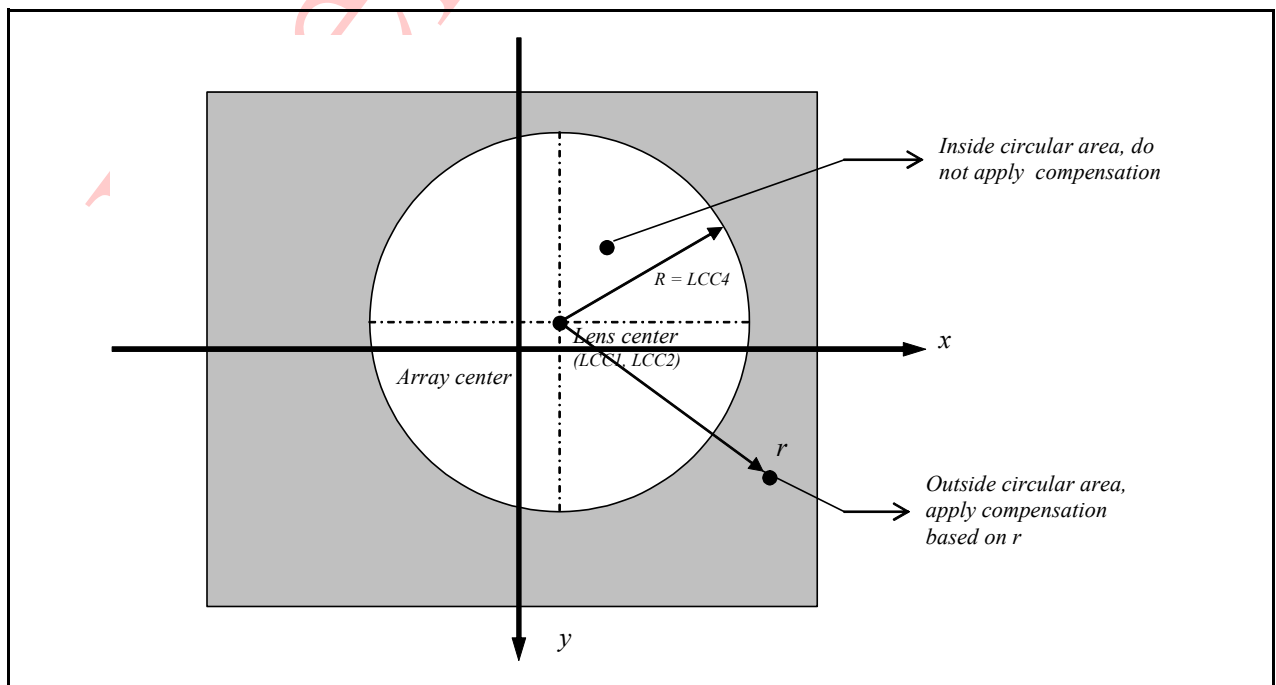

Table 5-8. Lens Shading Correction Registers and Parameters

Function	Register	Address	Note
X Coordinate of Lens Correction Center Relative to Array Center	LCC1	0x62	Bit[7] 0: Coordinate is - LCC1[6:0] (0x62) 1: Coordinate is + LCC1[6:0] (0x62)
Y Coordinate of Lens Correction Center Relative to Array Center	LCC2	0x63	Bit[7] 0: Coordinate is - LCC2[6:0] (0x62) 1: Coordinate is + LCC2[6:0] (0x62)
Radius of the circular section where no compensation applies	LCC4	0x65	
G Channel Compensation Coefficient when LCC5 (0x66) is 1 R, G, and B Channel Compensation Coefficient when LCC5 (0x66) is 0	LCC3	0x64	
Lens Correction Control	LCC5	0x66	Bit[2] 0: Apply same coefficient to R, G, and B channels 1: Apply different coefficient to R, G, and B channels Bit[0] 0: Disable lens correction function 1: Enable lens correction function
B Channel Compensation Coefficient	LCC6	0x94	Effective only when LCC5 (0x66) is 1
R Channel Compensation Coefficient	LCC7	0x95	Effective only when LCC5 (0x66) is 1

5.9 Brightness and Contrast Control

The OV7670/OV7171 has a built-in brightness and contrast function to easily control brightness and contrast. Table 5-9 lists the related registers and parameters.

Table 5-9. Brightness and Contrast Related Registers

Function	Register	Address	Description
Brightness Level	BRIGHT	0x55	Bit[7]: Sign bit 0: Positive 1: Negative Value of 0x00 and 0x80 means no brightness adjustment
Contrast Level	CONTRAS	0x56	The bigger this value, the higher the contrast. Default value is 0x40, meaning no contrast adjustment.
Center Luminance for Contrast Control	CONTRAS-CENTER	0x57	This register is automatically updated by the contrast function when register MTXS[7] (0x58) is 1; otherwise, the center luminance level is fixed to the value of this register which can be manually changed by the user.
Center Luminance Control Selection	MTXS[7]	0x58	0: Center luminance level is set manually using register CONTRAS-CENTER (0x57) 1: Center luminance level is controlled automatically and saved in register CONTRAS-CENTER (0x57)

6 Image Scaler

The OV7670/OV7171 CAMERACHIP allows outputs VGA and all other resolutions are scaled from VGA by the Image Scaler in digital domain.

6.1 Image Scaling

The Image Scaling circuit is composed of two blocks, Down Sampling and Digital Zoom Out, as shown in [Figure 6-1](#). Down Sampling supports $1/2^N$ scaling ratio and Digital Zoom Out performs fractional scaling. Due to the buffer size, the maximum size that Digital Zoom Out can support is CIF. Combining the scaling ratio of down sampling and digital zoom out, the OV7670/OV7171 CAMERACHIP can support VGA, CIF, and almost any size below CIF.

Figure 6-1 Image Scaling Circuit

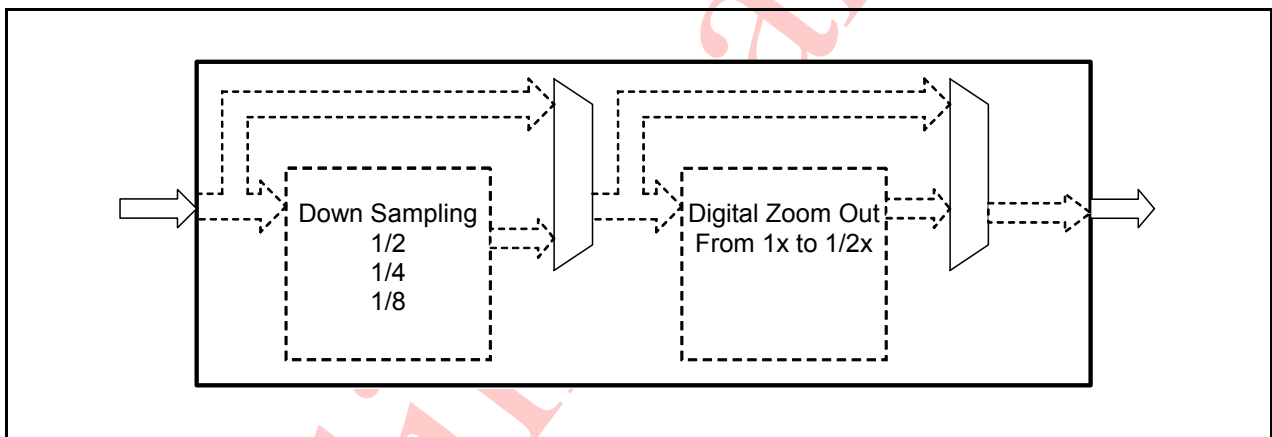

For example, to get a 256 x128 image, Down Sampling down samples VGA input to 320 x 240 by 1/2x ratio in both horizontal and vertical direction. Then, the Digital Zoom Out scales the 320x240 input to 125x128 by a scaling ratio of 0.8 horizontally and 0.53 vertically.

[Table 6-1](#) lists all the image scaling related registers and [Table 6-2](#) lists all the down sampling control related registers.

Table 6-1. Image Scaling Control Related Registers and Parameters

Function	Register	Address	Description
Digital Zoom Enable Bit	COM3[3]	0x0C	0: Bypass 1: Enable
Down Sampling Enable Bit	COM3[2]	0x0C	0: Disable 1: Enable
Down Sampling Related Control Register	SCALING_DCWCTR[7:0]	0x72	See Table 6-2
Pixel Clock Divider	SCALING_PCLK_DIV[3:0]	0x73	DSP Output Clock Divider Bit [3]: 0: Bypass 1: Enable Bit [2:0]: 000: Divider = 1 001: Divider = 2 010: Divider = 4 011: Divider = 8 100: Divider = 16 101: Divider = 32 110: Divider = 64 111: Divider = Not allowed
Horizontal Scaling Ratio	REG74[6:0]	0x74	From 1x (0x20) to 0.5x (0x40) Horizontal Scaling Ratio = $0x20 / (REG74[6:0])$
Vertical Scaling Ratio	REG75[6:0]	0x75	From 1x (0x20) to 0.5x (0x40) Vertical Scaling Ratio = $0x20 / (REG75[6:0])$
Pixel Clock Delay	SCALING_PCLK_DELAY[3:0]	0xA2	Original H size / Pixel clock divider - New H size

Table 6-2. Down Sampling Control Related Registers and Parameters

Function	Register	Address	Description
Option for Vertical Average Calculation	SCALING_DCWCTR[7]	0x72	0: Vertical truncation 1: Vertical rounding
Option for Vertical Down Sampling	SCALING_DCWCTR[6]	0x72	0: Vertical truncation 1: Vertical rounding
Vertical Down Sampling Rate	SCALING_DCWCTR[5:4]	0x72	00: No vertical down sampling 01: Vertical down sample by 2 10: Vertical down sample by 4 11: Vertical down sample by 8
Option for Horizontal Average Calculation	SCALING_DCWCTR[3]	0x72	0: Horizontal truncation 1: Horizontal rounding
Option for Horizontal Down Sampling	SCALING_DCWCTR[2]	0x72	0: Horizontal truncation 1: Horizontal rounding
Horizontal Down Sampling Rate	SCALING_DCWCTR[1:0]	0x72	00: No horizontal down sampling 01: Horizontal down sample by 2 10: Horizontal down sample by 4 11: Horizontal down sample by 8

6.2 Pixel Clock Divider

Because the new size of the image requires new timing, the Pixel Clock Divider adjusts the timing of the new size image. Its timing can be calculated as shown in [Table 6-3](#).

Table 6-3. Pixel Clock Divider

Horizontal Scaling Factor	Required Pixel Clock	Value For Register SCALING_PCLK_DIV[3:0] (0x73)
From 1x to 1/2x	1 Pixel Clock / Byte	0'b0000
From 1/2x to 1/4x	2 Pixel Clock / Byte	0'b0001
From 1/4x to 1/8x	4 Pixel Clock / Byte	0'b0010
1/8x to 1/16x	8 Pixel Clock / Byte	0'b0011

6.3 Pixel Clock Delay

In case a new scaled size (horizontally) is not a multiple number of the original sensor array resolution, there will be some timing offset (delay) in sending out a new size of the image with the original sensor array resolution clock. The pixel clock delay adjusts this timing offset (delay).

Its approximate value can be calculated using the equation shown below:

Pixel clock delay = Horizon pixel number of original sensor array / Pixel clock divider - Horizontal pixel number of new scaled image

6.4 Horizontal/Vertical Scaling Ratio

Registers **SCALING_XSC[6:0] (0x70)** and **SCALING_YSC[6:0] (0x71)** indicate horizontal/vertical scaling ratio in the digital zoom out circuit. A value of 0x20 or below indicates 1x scaling ratio and a value of 0x40 or higher indicates 0.5x scaling ratio. Its value can be calculated using the equation shown below:

Scaling ratio = 0x20 x Image Size from Down sampling circuit / New image size

6.5 Windowing

The OV7670/OV7171 CAMERACHIP windowing feature allows the user to select the window of interest. Selecting the Start/Stop Row/Column addresses (modifying window size and/or position) does not change the frame or data rate. When windowing is enabled, the HREF signal is asserted to be consistent with the programmed 'active' horizontal and vertical region. Table 6-4 lists the control registers

Table 6-4. Windowing Control Registers

Function	Register	Addresses
Horizontal Frame (HREF Column) Start	HSTART[7:0], HREF[2:0]	0x17, 0x32
Horizontal Frame (HREF Column) Stop	HSTOP[7:0], HREF[5:3]	0x18, 0x32
Vertical Frame (Row) Start	VSTRT[7:0], VREF[2:0]	0x19, 0x03
Vertical Frame (Row) Stop	VSTOP[7:0], VREF[5:3]	0x1A, 0x03

Figure 6-2 shows an example of a windowed frame.

Figure 6-2 Example of Windowing

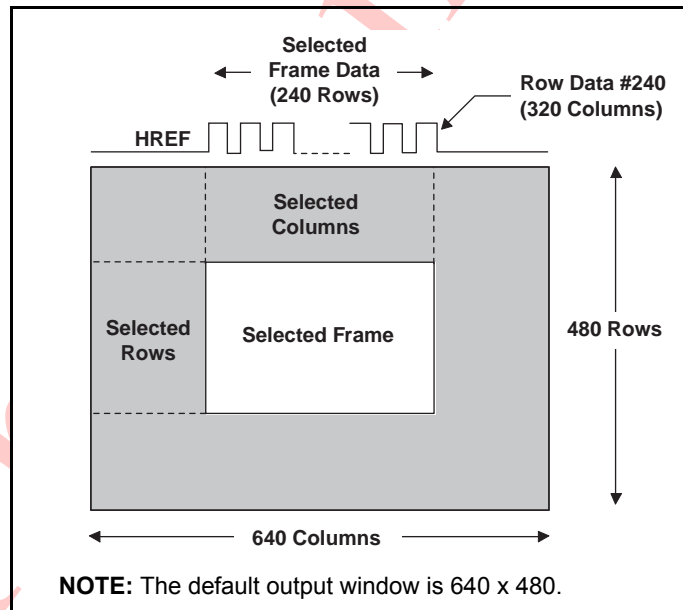

6.6 Data Formatting

RGB565 and RGB555 are alternate output formats where each color is represented by different D[7:0] bit widths (see Table 6-5).

Table 6-5. RGB555 and RGB565 Output Format Controls

Format	D[7:0]		
	Red	Green	Blue
RGB565	RRRR Rxxx	GGGG GGxx	BBBB Bxxx
RGB555	RRRR Rxxx	GGGG Gxxx	BBBB Bxxx

This format uses an odd/even byte pair to express the color for each pixel:

- RGB565

Bytes	D7	D6	D5	D4	D3	D2	D1	D0
Even	R7	R6	R5	R4	R3	G7	G6	G5
Odd	G4	G3	G2	B7	B6	B5	B4	B3

- RGB555

Bytes	D7	D6	D5	D4	D3	D2	D1	D0
Even	00	R7	R6	R5	R4	R3	G7	G6
Odd	G5	G4	G3	B7	B6	B5	B4	B3

See Figure 6-3 for details of MSB/LSB swap.

Figure 6-3 MSB/LSB Output Data Swap

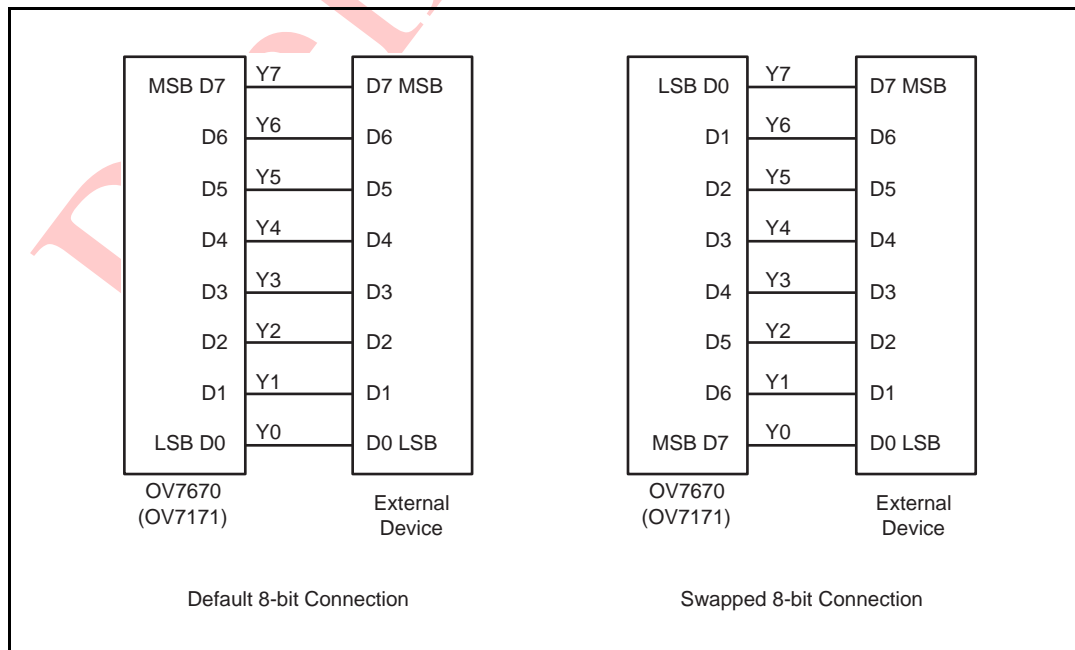

7 Digital Video Port

7.1 Drive Current

The two bits shown in [Table 7-1](#) are used to increase I_{OL}/I_{OH} drive current and can be adjusted as a function of the customer's D[9:0], HREF, VSYNC, and PCLK loading.

Table 7-1. Output Drive Current

Function	Register	Address	Description
Output Drive Capability	COM2[1:0]	0x09	Drive current: 00: 1x I_{OL}/I_{OH} Enable 01: 2x I_{OL}/I_{OH} Enable 10: 3x I_{OL}/I_{OH} Enable 11: 4x I_{OL}/I_{OH} Enable

7.2 Tri-state Enable

The digital video port can be tri-stated as shown in [Table 7-2](#), which is useful in dual camera applications.

Table 7-2. Tri-State Enable

Function	Register	Address	Description
Tri-State Enable	COM3[5]	0x0C	Tri-state PCLK, HREF/HSYNC, VSYNC, and STROBE in power-down mode, active low.
Tri-State Enable	COM3[4]	0x0C	Tri-state data bus D[7:0] in power-down mode, active low.

8 SCCB Interface

The *OmniVision Serial Camera Control Bus (SCCB) Functional Specification* is available at <http://www.ovt.com>. The Functional Specification provides complete information for using the SCCB to control the features of an OmniVision CAMERACHIP.

The OV7670/OV7171 CAMERACHIP uses the SCCB protocol to control the features noted in this document via the companion backend processor. The device slave addresses of the OV7670/OV7171 CAMERACHIP are: 0x42 for write and 0x43 for read. The first command in the SCCB transmission must be a register reset, as most registers will rely on the default value setting.

8.1 Control Functions

Table 8-1 lists the SCCB control functions.

Table 8-1. SCCB Control Functions

Function	Register	Address	Description
Register Reset	COM7[7]	0x12	0: Normal operation 1: Resets all registers, this bit is also reset to 0
Standby Mode Enable	COM2[4]	0x09	0: Disable standby mode 1: Enable standby mode

8.1.1 Register Reset

All registers can be reset to their default values by using the RESET pin (RESET to VDD_IO) or by using the SCCB interface (see register COM7[7] (0x12)). OmniVision suggests putting the reset register setting (set register COM7 (0x12) to 0x80) at the beginning of the sensor initialization. After software reset, wait 1 ms for the next register access (there is no limitation for other register settings).

8.1.2 Standby Mode Enable

The OV7670/OV7171 CAMERACHIP can be placed in Standby mode by using the PWDN pin (PWDN to VDD_IO) or by using the SCCB interface (see register COM2[4] (0x09)). Note that using the PWDN pin results in lower Standby current (see Electrical Characteristics in the *OV7670/OV7171 Datasheet*).

8.1.2.1 Standby Mode Using the PWDN Pin

Internal device clock is halted and all internal counters are reset to their default values and all SCCB registers remain unchanged.

8.1.2.2 Standby Mode Using the SCCB Interface

Suspends internal circuit activity but does not halt the device clock.

8.2 Register Set

Table 8-2 provides a list and description of the Device Control registers contained in the OV7670/OV7171. For all register Enable/Disable bits, ENABLE = 1 and DISABLE = 0. The device slave addresses for the OV7670/OV7171 are 0x42 for write and 0x43 for read.

For factory-recommended settings, contact your local OmniVision FAE.



Note: All registers shown as reserved have no function or are very sensitive analog circuit references. Use OmniVision reference values (not default values).

Table 8-2. Device Control Register List

Address (Hex)	Register Name	Default (Hex)	R/W	Description
00	GAIN	00	RW	AGC – Gain control gain setting Bit[7:0]: AGC[7:0] (see VREF[7:6] (0x03) for AGC[9:8]) • Range: [00] to [FF]
01	BLUE	80	RW	AWB – Blue channel gain setting • Range: [00] to [FF]
02	RED	80	RW	AWB – Red channel gain setting • Range: [00] to [FF]
03	VREF	03	RW	Vertical Frame Control Bit[7:6]: AGC[9:8] (see GAIN[7:0] (0x00) for AGC[7:0]) Bit[5:4]: Reserved Bit[3:2]: VREF end low 2 bits (high 8 bits at VSTOP[7:0]) Bit[1:0]: VREF start low 2 bits (high 8 bits at VSTRT[7:0])
04	COM1	00	RW	Common Control 1 Bit[7]: Reserved Bit[6]: CCIR656 format 0: Disable 1: Enable Bit[5:2]: Reserved Bit[1:0]: AEC low 2 LSB (see registers AECHH for AEC[15:10] and AECH for AEC[9:2])
05	BAVE	00	RW	U/B Average Level Automatically updated based on chip output format
06	GbAVE	00	RW	Y/Gb Average Level Automatically updated based on chip output format
07	AECHH	00	RW	Exposure Value - AEC MSB 5 bits Bit[7:6]: Reserved Bit[5:0]: AEC[15:10] (see registers AECH for AEC[9:2] and COM1 for AEC[1:0])
08	RAVE	00	RW	V/R Average Level Automatically updated based on chip output format

Table 8-2. Device Control Register List (Continued)

Address (Hex)	Register Name	Default (Hex)	R/W	Description
09	COM2	01	RW	Common Control 2 Bit[7:5]: Reserved Bit[4]: Soft sleep mode Bit[3:2]: Reserved Bit[1:0]: Output Drive Capability 00: 1x 01: 2x 10: 3x 11: 4x
0A	PID	76	R	Product ID Number MSB (Read only)
0B	VER	70	R	Product ID Number LSB (Read only)
0C	COM3	00	RW	Common Control 3 Bit[7]: Reserved Bit[6]: Output data MSB and LSB swap Bit[5]: Tri-state option for output clock (PCLK, HREF/HSYNC, VSYNC, and STROBE) at power-down period 0: Tri-state at this period 1: No tri-state at this period Bit[4]: Tri-state option for output data (D[7:0]) at power-down period 0: Tri-state at this period 1: No tri-state at this period Bit[3]: Scale enable 0: Disable 1: Enable - if set to a pre-defined format (see COM7[5:3]), then COM14[3] must be set to 1 for manual adjustment. Bit[2]: DCW enable 0: Disable 1: Enable - if set to a pre-defined format (see COM7[5:3]), then COM14[3] must be set to 1 for manual adjustment. Bit[1:0]: Reserved
0D	COM4	40	RW	Common Control 4 Bit[7:6]: Reserved Bit[5:4]: Average option (must be same value as COM17[7:6]) 00: Full window 01: 1/2 window 10: 1/4 window 11: 1/4 window Bit[3:0]: Reserved
0E	COM5	01	RW	Common Control 5 Bit[7:0]: Reserved

Table 8-2. Device Control Register List (Continued)

Address (Hex)	Register Name	Default (Hex)	R/W	Description															
0F	COM6	43	RW	Common Control 6 Bit[7]: Output of optical black row option 0: Disable HREF at optical black 1: Enable HREF at optical black Bit[6:2]: Reserved Bit[1]: Reset all timing when format changes 0: No reset 1: Resets timing Bit[0]: Reserved															
10	AECH	40	RW	Exposure Value Bit[7:0]: AEC[9:2] (see registers AECHH for AEC[15:10] and COM1 for AEC[1:0])															
11	CLKRC	80	RW	Internal Clock Bit[7]: Reserved Bit[6]: Use external clock directly (no clock pre-scale available) Bit[5:0]: Internal clock pre-scaler $F(\text{internal clock}) = F(\text{input clock}) / (\text{Bit}[5:0] + 1)$ • Range: [0 0000] to [1 1111]															
12	COM7	00	RW	Common Control 7 Bit[7]: SCCB register reset 0: No change 1: Resets all registers to default values Bit[6]: Reserved Bit[5]: Output format - CIF selection Bit[4]: Output format - QVGA selection Bit[3]: Output format - QCIF selection Bit[2]: Output format - RGB selection (see below) Bit[1]: Color bar 0: Disable 1: Enable Bit[0]: Output format - Raw RGB (see below) <table style="margin-left: auto; margin-right: auto; border-collapse: collapse;"> <thead> <tr> <th></th> <th>COM7[2]</th> <th>COM7[0]</th> </tr> </thead> <tbody> <tr> <td>YUV</td> <td style="text-align: center;">0</td> <td style="text-align: center;">0</td> </tr> <tr> <td>RGB</td> <td style="text-align: center;">1</td> <td style="text-align: center;">0</td> </tr> <tr> <td>Raw Bayer RGB</td> <td style="text-align: center;">0</td> <td style="text-align: center;">1</td> </tr> <tr> <td>Processed Bayer RGB</td> <td style="text-align: center;">1</td> <td style="text-align: center;">1</td> </tr> </tbody> </table>		COM7[2]	COM7[0]	YUV	0	0	RGB	1	0	Raw Bayer RGB	0	1	Processed Bayer RGB	1	1
	COM7[2]	COM7[0]																	
YUV	0	0																	
RGB	1	0																	
Raw Bayer RGB	0	1																	
Processed Bayer RGB	1	1																	

Table 8-2. Device Control Register List (Continued)

Address (Hex)	Register Name	Default (Hex)	R/W	Description
13	COM8	8F	RW	Common Control 8 Bit[7]: Enable fast AGC/AEC algorithm Bit[6]: AEC - Step size limit 0: Step size is limited to vertical blank 1: Unlimited step size Bit[5]: Banding filter ON/OFF - In order to turn ON the banding filter, BD50ST (0x9D) or BD60ST (0x9E) must be set to a non-zero value. 0: ON 1: OFF Bit[4:3]: Reserved Bit[2]: AGC Enable Bit[1]: AWB Enable Bit[0]: AEC Enable
14	COM9	4A	RW	Common Control 9 Bit[7]: Reserved Bit[6:4]: Automatic Gain Ceiling - maximum AGC value 000: 2x 001: 4x 010: 8x 011: 16x 100: 32x 101: 64x 110: 128x 111: Not allowed Bit[3:1]: Reserved Bit[0]: Freeze AGC/AEC
15	COM10	00	RW	Common Control 10 Bit[7]: Reserved Bit[6]: HREF changes to HSYNC Bit[5]: PCLK output option 0: Free running PCLK 1: PCLK does not toggle during horizontal blank Bit[4]: PCLK reverse Bit[3]: HREF reverse Bit[2]: VSYNC option 0: VSYNC changes on falling edge of PCLK 1: VSYNC changes on rising edge of PCLK Bit[1]: VSYNC negative Bit[0]: HSYNC negative
16	RSVD	XX	–	Reserved
17	HSTART	11	RW	Output Format - Horizontal Frame (HREF column) start high 8-bit (low 3 bits are at HREF [2:0])
18	HSTOP	61	RW	Output Format - Horizontal Frame (HREF column) end high 8-bit (low 3 bits are at HREF [5:3])

Table 8-2. Device Control Register List (Continued)

Address (Hex)	Register Name	Default (Hex)	R/W	Description
19	VSTRT	03	RW	Output Format - Vertical Frame (row) start high 8-bit (low 2 bits are at VREF[1:0])
1A	VSTOP	7B	RW	Output Format - Vertical Frame (row) end high 8-bit (low 2 bits are at VREF[3:2])
1B	PSHFT	00	RW	Data Format - Pixel Delay Select (delays timing of the D[7:0] data relative to HREF in pixel units) • Range: [00] (no delay) to [FF] (256 pixel delay which accounts for whole array)
1C	MIDH	7F	R	Manufacturer ID Byte – High (Read only = 0x7F)
1D	MIDL	A2	R	Manufacturer ID Byte – Low (Read only = 0xA2)
1E	MVFP	00	RW	Mirror/VFlip Enable Bit[7:6]: Reserved Bit[5]: Mirror 0: Normal image 1: Mirror image Bit[4]: VFlip enable 0: Normal image 1: Vertically flip image Bit[3]: Reserved Bit[2]: Black sun enable Bit[1:0]: Reserved
1F	LAEC	00	RW	Reserved
20	ADCCTR0	04	RW	ADC Control Bit[7:4]: Reserved Bit[3]: ADC range adjustment 0: 1x range 1: 1.5x range Bit[2:0]: ADC reference adjustment 000: 0.8x 100: 1x 111: 1.2x
21	ADCCTR1	02	RW	Bit[7:0]: Reserved
22	ADCCTR2	01	RW	Bit[7:0]: Reserved
23	ADCCTR3	80	RW	Bit[7:0]: Reserved
24	AEW	75	RW	AGC/AEC - Stable Operating Region (Upper Limit)
25	AEB	63	RW	AGC/AEC - Stable Operating Region (Lower Limit)
26	VPT	D4	RW	AGC/AEC Fast Mode Operating Region Bit[7:4]: High nibble of upper limit of fast mode control zone Bit[3:0]: High nibble of lower limit of fast mode control zone

Table 8-2. Device Control Register List (Continued)

Address (Hex)	Register Name	Default (Hex)	R/W	Description
27	BBIAS	80	RW	B Channel Signal Output Bias (effective only when COM6[3] = 1) Bit[7]: Bias adjustment sign 0: Add bias 1: Subtract bias Bit[6:0]: Bias value of 10-bit range
28	GbBIAS	80	RW	Gb Channel Signal Output Bias (effective only when COM6[3] = 1) Bit[7]: Bias adjustment sign 0: Add bias 1: Subtract bias Bit[6:0]: Bias value of 10-bit range
29	RSVD	XX	–	Reserved
2A	EXHCH	00	RW	Dummy Pixel Insert MSB Bit[7:4]: 4 MSB for dummy pixel insert in horizontal direction Bit[3:2]: HSYNC falling edge delay 2 MSB Bit[1:0]: HSYNC rising edge delay 2 MSB
2B	EXHCL	00	RW	Dummy Pixel Insert LSB 8 LSB for dummy pixel insert in horizontal direction
2C	RBIAS	80	RW	R Channel Signal Output Bias (effective only when COM6[3] = 1) Bit[7]: Bias adjustment sign 0: Add bias 1: Subtract bias Bit[6:0]: Bias value of 10-bit range
2D	ADVFL	00	RW	LSB of insert dummy rows in vertical direction (1 bit equals 1 row)
2E	ADVFLH	00	RW	MSB of insert dummy rows in vertical direction
2F	YAVE	00	RW	Y/G Channel Average Value
30	HSYST	08	RW	HSYNC Rising Edge Delay (low 8 bits)
31	HSYEN	30	RW	HSYNC Falling Edge Delay (low 8 bits)
32	HREF	80	RW	HREF Control Bit[7:6]: HREF edge offset to data output Bit[5:3]: HREF end 3 LSB (high 8 MSB at register HSTOP) Bit[2:0]: HREF start 3 LSB (high 8 MSB at register HSTART)
33	CHLF	08	RW	Array Current Control Bit[7:0]: Reserved
34	ARBLM	03	RW	Array Reference Control Bit[7:0]: Reserved
35-36	RSVD	XX	–	Reserved
37	ADC	04	RW	ADC Control Bit[7:0]: Reserved

Table 8-2. Device Control Register List (Continued)

Address (Hex)	Register Name	Default (Hex)	R/W	Description
38	ACOM	12	RW	ADC and Analog Common Mode Control Bit[7:0]: Reserved
39	OFON	00	RW	ADC Offset Control Bit[7:0]: Reserved
3A	TSLB	0C	RW	Line Buffer Test Option Bit[7:6]: Reserved Bit[5]: Negative image enable 0: Normal image 1: Negative image Bit[4]: UV output value 0: Use normal UV output 1: Use fixed UV value set in registers MANU and MANV as UV output instead of chip output Bit[3]: Output sequence (use with register COM13 [1] (0x3D)) TSLB[3], COM13 [1]: 00: Y U Y V 01: Y V Y U 10: U Y V Y 11: V Y U Y Bit[2:1]: Reserved Bit[0]: Auto output window 0: Sensor DOES NOT automatically set window after resolution change. The companion backend processor can adjust the output window immediately after changing the resolution 1: Sensor automatically sets output window when resolution changes. After resolution changes, the companion backend processor must adjust the output window after the next VSYNC pulse.

Table 8-2. Device Control Register List (Continued)

Address (Hex)	Register Name	Default (Hex)	R/W	Description
3B	COM11	00	RW	<p>Common Control 11</p> <p>Bit[7]: Night mode 0: Night mode disable 1: Night mode enable - The frame rate is reduced automatically while the minimum frame rate is limited by COM11[6:5]. Also, ADVFH and ADVFL will be automatically updated.</p> <p>Bit[6:5]: Minimum frame rate of night mode 00: Same as normal mode frame rate 01: 1/2 of normal mode frame rate 10: 1/4 of normal mode frame rate 11: 1/8 of normal mode frame rate</p> <p>Bit[4]: D56_Auto 0: Disable 50/60 Hz auto detection 1: Enable 50/60 Hz auto detection</p> <p>Bit[3]: Banding filter value select (effective only when COM11[4] = 0) 0: Select BD60ST[7:0] (0x9E) as Banding Filter Value 1: Select BD50ST[7:0] (0x9D) as Banding Filter Value</p> <p>Bit[2]: Reserved</p> <p>Bit[1]: Exposure timing can be less than limit of banding filter when light is too strong</p> <p>Bit[0]: Reserved</p>
3C	COM12	40	RW	<p>Common Control 12</p> <p>Bit[7]: HREF option 0: No HREF when VSYNC is low 1: Always has HREF</p> <p>Bit[6:0]: Reserved</p>
3D	COM13	99	RW	<p>Common Control 13</p> <p>Bit[7]: Gamma enable</p> <p>Bit[6]: UV saturation level - UV auto adjustment. Result is saved in register SATCTR[3:0] (0xC9)</p> <p>Bit[5:2]: Reserved</p> <p>Bit[1]: UV swap (use with register TSLB[3] (0x3A)) TSLB[3], COM13[1]: 00: Y U Y V 01: Y V Y U 10: U Y V Y 11: V Y U Y</p> <p>Bit[0]: Reserved</p>

Table 8-2. Device Control Register List (Continued)

Address (Hex)	Register Name	Default (Hex)	R/W	Description
3E	COM14	0E	RW	<p>Common Control 14</p> <p>Bit[7:5]: Reserved</p> <p>Bit[4]: DCW and scaling PCLK enable 0: Normal PCLK 1: DCW and scaling PCLK, controlled by register COM14[2:0] and SCALING_PCLK_DIV[3:0] (0x73))</p> <p>Bit[3]: Manual scaling enable for pre-defined resolution modes such as CIF, QCIF, and QVGA 0: Scaling parameter cannot be adjusted manually 1: Scaling parameter can be adjusted manually</p> <p>Bit[2:0]: PCLK divider (only when COM14[4] = 1) 000: Divided by 1 001: Divided by 2 010: Divided by 4 011: Divided by 8 100: Divided by 16 101~111: Not allowed</p>
3F	EDGE	88	RW	<p>Edge Enhancement Adjustment</p> <p>Bit[7:5]: Reserved</p> <p>Bit[4:0]: Edge enhancement factor</p>
40	COM15	C0	RW	<p>Common Control 15</p> <p>Bit[7:6]: Data format - output full range enable 0x: Output range: [10] to [F0] 10: Output range: [01] to [FE] 11: Output range: [00] to [FF]</p> <p>Bit[5:4]: RGB 555/565 option (must set COM7[2] = 1 and COM7[0] = 0) x0: Normal RGB output 01: RGB 565 11: RGB 555</p> <p>Bit[3:0]: Reserved</p>

Table 8-2. Device Control Register List (Continued)

Address (Hex)	Register Name	Default (Hex)	R/W	Description
41	COM16	10	RW	Common Control 16 Bit[7:6]: Reserved Bit[5]: Enable edge enhancement auto-adjustment for YUV output (result is saved in register EDGE[4:0] (0x3F) and range is controlled by registers REG75[4:0] (0x75) and REG76[4:0] (0x76)) 0: Disable 1: Enable Bit[4]: De-noise auto-adjustment (result is saved in register DNSTH (0x4C) and range is controlled by register REG77[7:0] (0x77)) 0: Disable 1: Enable Bit[3]: AWB gain enable Bit[2]: Reserved Bit[1]: Color matrix coefficient double option 0: Original matrix 1: Double of original matrix Bit[0]: Reserved
42	COM17	08	RW	Common Control 17 Bit[7:6]: AEC window must be the same value as COM4[5:4] 00: Normal 01: 1/2 10: 1/4 11: 1/4 Bit[5:4]: Reserved Bit[3]: DSP color bar enable 0: Disable 1: Enable Bit[2:0]: Reserved
43	AWBC1	14	RW	AWB Control 1
44	AWBC2	F0	RW	AWB Control 2
45	AWBC3	45	RW	AWB Control 3
46	AWBC4	61	RW	AWB Control 4
47	AWBC5	51	RW	AWB Control 5
48	AWBC6	79	RW	AWB Control 6
49-4A	RSVD	XX	–	Reserved
4B	REG4B	00	RW	Register 4B Bit[7:1]: Reserved Bit[0]: UV average enable
4C	DNSTH	00	RW	De-noise Strength

Table 8-2. Device Control Register List (Continued)

Address (Hex)	Register Name	Default (Hex)	R/W	Description
4D	DM_POS	00	RW	Bit[7]: Dummy row position 0: Dummy row is inserted before active row 1: Dummy row is inserted after active row Bit[6:0]: Reserved
4E	RSVD	XX	–	Reserved
4F	MTX1	40	RW	Matrix Coefficient 1
50	MTX2	34	RW	Matrix Coefficient 2
51	MTX3	0C	RW	Matrix Coefficient 3
52	MTX4	17	RW	Matrix Coefficient 4
53	MTX5	29	RW	Matrix Coefficient 5
54	MTX6	40	RW	Matrix Coefficient 6
55	BRIGHT	00	RW	Brightness Control
56	CONTRAS	40	RW	Contrast Control
57	CONTRAS-CENTER	80	RW	Contrast Center
58	MTXS	1E	RW	Matrix Coefficient Sign for coefficient 5 to 0 Bit[7]: Auto contrast center enable 0: Disable, center is set by register CONTRAS-CENTER (0x57) 1: Enable, register CONTRAS-CENTER is updated automatically Bit[6]: Reserved Bit[5:0]: Matrix coefficient sign 0: Plus 1: Minus
59	AWBC7	91	RW	AWB Control 7
5A	AWBC8	94	RW	AWB Control 8
5B	AWBC9	AA	RW	AWB Control 9
5C	AWBC10	71	RW	AWB Control 10
5D	AWBC11	8D	RW	AWB Control 11
5E	AWBC12	0F	RW	AWB Control 12
5F	B_LMT	F0	RW	AWB B Gain Range {B_LMT[7:4], 4'hF}, {4'h0, B_LMT[3:0]}
60	R_LMT	F0	RW	AWB R Gain Range {R_LMT[7:4], 4'hF}, {4'h0, R_LMT[3:0]}
61	G_LMT	F0	RW	AWB G Gain Range {G_LMT[7:4], 4'hF}, {4'h0, G_LMT[3:0]}

Table 8-2. Device Control Register List (Continued)

Address (Hex)	Register Name	Default (Hex)	R/W	Description
62	LCC1	00	RW	Lens Correction Option 1 - X Coordinate of Lens Correction Center Relative to Array Center
63	LCC2	00	RW	Lens Correction Option 2 - Y Coordinate of Lens Correction Center Relative to Array Center
64	LCC3	10	RW	Lens Correction Option 3 G Channel Compensation Coefficient when LCC5[2] (0x66) is 1 R, G, and B Channel Compensation Coefficient when LCC5[2] (0x66) is 0
65	LCC4	80	RW	Lens Correction Option 4 - Radius of the circular section where no compensation applies
66	LCC5	00	RW	Lens Correction Control Bit[7:3]: Reserved Bit[2]: Lens correction control select 0: R, G, and B channel compensation coefficient is set by register LCC3 1: R, G, and B channel compensation coefficient is set by registers LCC6, LCC3, and LCC7, respectively Bit[1]: Reserved Bit[0]: Lens correction enable 0: Disable 1: Enable
67	MANU	80	RW	Manual U Value (effective only when register TSLB[4] is high)
68	MANV	80	RW	Manual V Value (effective only when register TSLB[4] is high)
69	GFIX	00	RW	Fix Gain Control Bit[7:6]: Fix gain for Gr channel 00: 1x 01: 1.25x 10: 1.5x 11: 1.75x Bit[5:4]: Fix gain for Gb channel 00: 1x 01: 1.25x 10: 1.5x 11: 1.75x Bit[3:2]: Fix gain for R channel 00: 1x 01: 1.25x 10: 1.5x 11: 1.75x Bit[1:0]: Fix gain for B channel 00: 1x 01: 1.25x 10: 1.5x 11: 1.75x
6A	GGAIN	00	RW	G Channel AWB Gain

Table 8-2. Device Control Register List (Continued)

Address (Hex)	Register Name	Default (Hex)	R/W	Description
6B	DBLV	3A	RW	Bit[7:6]: PLL control 00: Bypass PLL 01: Input clock x4 10: Input clock x6 11: Input clock x8 Bit[5]: Reserved Bit[4]: Regulator control 0: Enable internal regulator 1: Bypass internal regulator Bit[3:0]: Clock divider control for DSP scale control (valid only when COM14[3] = 1)
6C	AWBCTR3	02	RW	AWB Control 3
6D	AWBCTR2	55	RW	AWB Control 2
6E	AWBCTR1	00	RW	AWB Control 1
6F	AWBCTR0	9A	RW	AWB Control 0
70	SCALING_XSC	4A	RW	Bit[7]: Test_pattern[0] - works with test_pattern[1] test_pattern (SCALING_XSC[7], SCALING_YSC[7]): 00: No test pattern output 01: Shifting "1" 10: 8-bar color bar 11: Fade to gray color bar Bit[6:0]: Horizontal scale factor
71	SCALING_YSC	35	RW	Bit[7]: Test_pattern[1] - works with test_pattern[0] test_pattern (SCALING_XSC[7], SCALING_YSC[7]): 00: No test pattern output 01: Shifting "1" 10: 8-bar color bar 11: Fade to gray color bar Bit[6:0]: Vertical scale factor

Table 8-2. Device Control Register List (Continued)

Address (Hex)	Register Name	Default (Hex)	R/W	Description
72	SCALING_DCWCTR	11	RW	DCW Control Bit[7]: Vertical average calculation option 0: Vertical truncation 1: Vertical rounding Bit[6]: Vertical down sampling option 0: Vertical truncation 1: Vertical rounding Bit[5:4]: Vertical down sampling rate 00: No vertical down sampling 01: Vertical down sample by 2 10: Vertical down sample by 4 11: Vertical down sample by 8 Bit[3]: Horizontal average calculation option 0: Horizontal truncation 1: Horizontal rounding Bit[2]: Horizontal down sampling option 0: Horizontal truncation 1: Horizontal rounding Bit[1:0]: Horizontal down sampling rate 00: No horizontal down sampling 01: Horizontal down sample by 2 10: Horizontal down sample by 4 11: Horizontal down sample by 8
73	SCALING_PCLK_DIV	00	RW	Bit[7:4]: Reserved Bit[3]: Bypass clock divider for DSP scale control 0: Enable clock divider 1: Bypass clock divider Bit[2:0]: Clock divider control for DSP scale control (valid only when COM14[3] = 1). Should change with COM14[2:0]. 000: Divided by 1 001: Divided by 2 010: Divided by 4 011: Divided by 8 100: Divided by 16 101~111: Not allowed
74	REG74	00	RW	Bit[7:5]: Reserved Bit[4]: Digital gain control select 0: Digital gain control by VREF[7:6] 1: Digital gain control by REG74[1:0] Bit[3:2]: Reserved Bit[1:0]: Digital gain manual control 00: Bypass 01: 1x 10: 2x 11: 4x
75	REG75	0F	RW	Register 75 Bit[7:5]: Reserved Bit[4:0]: Edge enhancement lower limit

Table 8-2. Device Control Register List (Continued)

Address (Hex)	Register Name	Default (Hex)	R/W	Description
76	REG76	01	RW	Register 76 Bit[7]: Reserved Bit[6]: White pixel correction enable 0: Disable 1: Enable Bit[5]: Black pixel correction enable 0: Disable 1: Enable Bit[4:0]: Edge enhancement higher limit
77	REG77	10	RW	Register 77 Bit[7:0]: Offset, de-noise range control
78-79	RSVD	XX	–	Reserved
7A	SLOP	18	RW	Gamma Curve Highest Segment Slop - calculated as follows: $SLOP[7:0] = (0x100 - GAM15[7:0]) \times 4/3$
7B	GAM1	02	RW	Gamma Curve 1st Segment Input End Point 0x04 Output Value
7C	GAM2	07	RW	Gamma Curve 2nd Segment Input End Point 0x08 Output Value
7D	GAM3	1F	RW	Gamma Curve 3rd Segment Input End Point 0x10 Output Value
7E	GAM4	49	RW	Gamma Curve 4th Segment Input End Point 0x20 Output Value
7F	GAM5	5A	RW	Gamma Curve 5th Segment Input End Point 0x28 Output Value
80	GAM6	6A	RW	Gamma Curve 6th Segment Input End Point 0x30 Output Value
81	GAM7	79	RW	Gamma Curve 7th Segment Input End Point 0x38 Output Value
82	GAM8	87	RW	Gamma Curve 8th Segment Input End Point 0x40 Output Value
83	GAM9	94	RW	Gamma Curve 9th Segment Input End Point 0x48 Output Value
84	GAM10	9F	RW	Gamma Curve 10th Segment Input End Point 0x50 Output Value
85	GAM11	AF	RW	Gamma Curve 11th Segment Input End Point 0x60 Output Value
86	GAM12	BB	RW	Gamma Curve 12th Segment Input End Point 0x70 Output Value
87	GAM13	CF	RW	Gamma Curve 13th Segment Input End Point 0x90 Output Value
88	GAM14	EE	RW	Gamma Curve 14th Segment Input End Point 0xB0 Output Value
89	GAM15	EE	RW	Gamma Curve 15th Segment Input End Point 0xD0 Output Value
8A-91	RSVD	XX	–	Reserved
92	DM_LNL	00	RW	Dummy Row low 8 bits
93	DM_LNH	00	RW	Dummy Row high 8 bits
94	LCC6	50	RW	Lens Correction Option 6 (effective only when LCC5[2] is high)
95	LCC7	50	RW	Lens Correction Option 7 (effective only when LCC5[2] is high)
96-9C	RSVD	XX	–	Reserved

Table 8-2. Device Control Register List (Continued)

Address (Hex)	Register Name	Default (Hex)	R/W	Description
9D	BD50ST	99	RW	50 Hz Banding Filter Value (effective only when COM8[5] is high and COM11[3] is high)
9E	BD60ST	7F	RW	60 Hz Banding Filter Value (effective only when COM8[5] is high and COM11[3] is low)
9F	HRL	C0	RW	High Reference Luminance
A0	LRL	90	RW	Low Reference Luminance
A1	DSPC3	03	RW	DSP Control 3
A2	SCALING_PCLK_DELAY	02	RW	Pixel Clock Delay
A3	RSVD	XX	–	Reserved
A4	NT_CTRL	00	RW	Bit[7:4]: Reserved Bit[3]: Auto frame rate adjustment dummy row selection 0: N is equal to the maximum exposure, time less than frame period when banding filter is enabled 1: N is equal to the number of rows per frame Bit[2]: Reserved Bit[1:0]: Auto frame rate adjustment switch point 00: Insert dummy row at 2x gain 01: Insert dummy row at 4x gain 10: Insert dummy row at 8x gain
A5	AECGMAX	0F	RW	Maximum Banding Filter Step
A6	LPH	F0	RW	Lower Limit of Probability for HRL, after exposure/gain stabilizes
A7	UPL	C1	RW	Upper Limit of Probability for LRL, after exposure/gain stabilizes
A8	TPL	F0	RW	Probability Threshold for LRL to control AEC/AGC speed
A9	TPH	C1	RW	Probability Threshold for HRL to control AEC/AGC speed
AA	NALG	14	RW	Bit[7]: AEC algorithm selection 0: Average-based AEC algorithm 1: Histogram-based AEC algorithm Bit[6:0]: Reserved
AB	RSVD	XX	–	Reserved

Table 8-2. Device Control Register List (Continued)

Address (Hex)	Register Name	Default (Hex)	R/W	Description
AC	STR-OPT	00	RW	Register AC Bit[7]: Strobe enable Bit[6]: R / G / B gain controlled by STR_R (0xAD) / STR_G (0xAE) / STR_B (0xAF) for LED output frame Bit[5:4]: Xenon mode option 00: 1 row 01: 2 rows 10: 3 rows 11: 4 rows Bit[3:2]: Reserved Bit[1:0]: Mode select 00: Xenon 01: LED 1 1x: LED 2
AD	STR_R	80	RW	R Gain for LED Output Frame
AE	STR_G	80	RW	G Gain for LED Output Frame
AF	STR_B	80	RW	B Gain for LED Output Frame
B0	RSVD	XX	–	Reserved
B1	ABLC1	00	RW	Bit[7:3]: Reserved Bit[2]: ABLC enable 0: Disable ABLC function, BLC function is still active 1: Enable ABLC function Bit[1:0]: Reserved
B2	RSVD	XX	–	Reserved
B3	THL_ST	80	RW	ABLC Target
B4	RSVD	XX	–	Reserved
B5	THL_DLT	04	RW	ABLC Stable Range
B6-BD	RSVD	XX	–	Reserved
BE	AD-CHB	00	RW	Blue Channel Black Level Compensation Bit[7]: Reserved Bit[6]: Sign bit Bit[5:0]: Blue channel black level compensation
BF	AD-CHR	00	RW	Red Channel Black Level Compensation Bit[7]: Reserved Bit[6]: Sign bit Bit[5:0]: Red channel black level compensation
C0	AD-CHGb	00	RW	Gb Channel Black Level Compensation Bit[7]: Reserved Bit[6]: Sign bit Bit[5:0]: Gb channel black level compensation

Table 8-2. Device Control Register List (Continued)

Address (Hex)	Register Name	Default (Hex)	R/W	Description
C1	AD-CHGr	00	RW	Gr Channel Black Level Compensation Bit[7]: Reserved Bit[6]: Sign bit Bit[5:0]: Gr channel black level compensation
C2-C8	RSVD	XX	–	Reserved
C9	SATCTR	C0	RW	Saturation Control Bit[7:4]: UV saturation control minimum Bit[3:0]: UV saturation control result

NOTE: All other registers are factory-reserved. Please contact OmniVision Technologies for reference register settings.

9 Prototyping and Evaluation Modules

OmniVision Technologies Inc. supplies prototyping and evaluation modules to demonstrate operation of the associated CAMERACHIP products, as well as to demonstrate associated companion backend processor, where required.

9.1 OV7670/OV7171EAA Prototyping Module

The OV7670/OV7171EAA prototyping module is used for general design-in and evaluation purposes. The module provides a simple 32-pin header-connector interface to the relevant I/O and control registers in the OV7670/OV7171 CAMERACHIP. The module includes the necessary sensor, lens/holder, a few capacitors, and resistors.

The OV7670/OV7171EAA prototyping module can be directly connected to any companion backend processor solution or system interface. The header-connector interface allows for access to the 10-bit digital output data, PCLK, vertical sync, horizontal sync and SCCB signals. The backend interface can use the Serial Camera Control Bus (SCCB) interface software to adjust the control register values.

9.2 OV7670/OV7171ECX USB 2.0 Evaluation Module

The OV7670/OV7171ECX USB2.0 evaluation module is provided so that potential customers may evaluate both the live video function of the CAMERACHIP as well as the SCCB control interface software. The OV7670/OV7171 CAMERACHIP output is a RGB raw data or YUV stream connected to a USB 2.0 controller operating at a high-speed bus data rate (480 Mbps).

Using a high performance computer system with a USB 2.0 host (cannot guarantee for every system), the OV7670/OV7171 USB module will stream video in VGA format (640x480 at 30 fps) or in QVGA format (320x240 at 60 fps). This configuration requires a Windows® 2000 or XP operating system. Additionally, the SCCB software allows the evaluator to adjust the image characteristics in real-time.

10 Lens selection

The OV7670/OV7171 is a one-sixth-inch format CAMERACHIP that is compatible with numerous lenses in the market. The key considerations in lens selection are lens quality and resultant cost. OmniVision Technologies, Inc. has qualified several lens suppliers for the various formats, sizes, and quality of lenses available. OmniVision has developed a Lens Supplier Partner List to complement our CAMERACHIP products. This listing is available at <http://www.ovt.com> on the Partners page. Contact your local OmniVision FAE for recommended OV7670/OV7171 lenses.

11 OV7670/OV7171 Bug List

None as of this revision.

Appendix A Reference SCCB Settings

Contact your local OmniVision FAE for updated reference register settings.

Preliminary