

## 2.4-GHz *Bluetooth*™ low energy and Proprietary System-on-Chip

Check for Samples: [CC2541](#)

### FEATURES

- **RF**
  - 2.4-GHz *Bluetooth* low energy Compliant and Proprietary RF System-on-Chip
  - Supports 250-kbps, 500-kbps, 1-Mbps, 2-Mbps Data Rates
  - Excellent Link Budget, Enabling Long-Range Applications Without External Front End
  - Programmable Output Power up to 0 dBm
  - Excellent Receiver Sensitivity (–94 dBm at 1 Mbps), Selectivity, and Blocking Performance
  - Suitable for Systems Targeting Compliance With Worldwide Radio Frequency Regulations: ETSI EN 300 328 and EN 300 440 Class 2 (Europe), FCC CFR47 Part 15 (US), and ARIB STD-T66 (Japan)
- **Layout**
  - Few External Components
  - Reference Design Provided
  - 6-mm × 6-mm QFN-40 Package
  - Pin-Compatible With CC2540 (When Not Using USB or I<sup>2</sup>C)
- **Low Power**
  - Active-Mode RX Down to: 17.9 mA
  - Active-Mode TX (0 dBm): 18.2 mA
  - Power Mode 1 (4-μs Wake-Up): 270 μA
  - Power Mode 2 (Sleep Timer On): 1 μA
  - Power Mode 3 (External Interrupts): 0.5 μA
  - Wide Supply-Voltage Range (2 V–3.6 V)
- **TPS62730 Compatible Low Power in Active Mode**
  - RX Down to: 14.7 mA (3-V supply)
  - TX (0 dBm): 14.3 mA (3-V supply)
- **High-Performance and Low-Power 8051 Microcontroller Core With Code Prefetch**
  - In-System-Programmable Flash, 128- or 256-KB
  - 8-KB RAM With Retention in All Power Modes
  - Hardware Debug Support
  - Extensive Baseband Automation, Including Auto-Acknowledgment and Address Decoding
  - Retention of All Relevant Registers in All Power Modes
- **Peripherals**
  - Powerful Five-Channel DMA
  - General-Purpose Timers (One 16-Bit, Two 8-Bit)
  - IR Generation Circuitry
  - 32-kHz Sleep Timer With Capture
  - Accurate Digital RSSI Support
  - Battery Monitor and Temperature Sensor
  - 12-Bit ADC With Eight Channels and Configurable Resolution
  - AES Security Coprocessor
  - Two Powerful USARTs With Support for Several Serial Protocols
  - 23 General-Purpose I/O Pins (21 × 4 mA, 2 × 20 mA)
  - I<sup>2</sup>C interface
  - 2 I/O Pins Have LED Driving Capabilities
  - Watchdog Timer
  - Integrated High-Performance Comparator
- **Development Tools**
  - CC2541 Evaluation Module Kit (CC2541EMK)
  - CC2541 Mini Development Kit (CC2541DK-MINI)
  - SmartRF™ Software
  - IAR Embedded Workbench™ Available
- **Microcontroller**



Please be aware that an important notice concerning availability, standard warranty, and use in critical applications of Texas Instruments semiconductor products and disclaimers thereto appears at the end of this data sheet.

Bluetooth is a trademark of Bluetooth SIG, Inc..

ZigBee is a registered trademark of ZigBee Alliance.

## SOFTWARE FEATURES

- **Bluetooth v4.0 Compliant Protocol Stack for Single-Mode BLE Solution**
  - Complete Power-Optimized Stack, Including Controller and Host
    - GAP – Central, Peripheral, Observer, or Broadcaster (Including Combination Roles)
    - ATT / GATT – Client and Server
    - SMP – AES-128 Encryption and Decryption
    - L2CAP
  - Sample Applications and Profiles
    - Generic Applications for GAP Central and Peripheral Roles
    - Proximity, Accelerometer, Simple Keys, and Battery GATT Services
    - More Applications Supported in [BLE Software Stack](#)
  - Multiple Configuration Options
    - Single-Chip Configuration, Allowing Applications to Run on CC2541
    - Network Processor Interface for Applications Running on an External Microcontroller
  - BTool – Windows PC Application for Evaluation, Development, and Test

## APPLICATIONS

- 2.4-GHz *Bluetooth* low energy Systems
- Proprietary 2.4-GHz Systems
- Human-Interface Devices (Keyboard, Mouse, Remote Control)
- Sports and Leisure Equipment
- Mobile Phone Accessories
- Consumer Electronics

## CC2541 WITH [TPS62730](#)

- [TPS62730](#) is a 2-MHz Step-Down Converter With Bypass Mode
- Extends Battery Lifetime by up to 20%
- Reduced Current in All Active Modes
- 30-nA Bypass Mode Current to Support Low-Power Modes
- RF Performance Unchanged
- Small Package Allows for Small Solution Size
- CC2541 Controllable

## DESCRIPTION

The CC2541 is a power-optimized true system-on-chip (SoC) solution for both *Bluetooth* low energy and proprietary 2.4-GHz applications. It enables robust network nodes to be built with low total bill-of-material costs. The CC2541 combines the excellent performance of a leading RF transceiver with an industry-standard enhanced 8051 MCU, in-system programmable flash memory, 8-KB RAM, and many other powerful supporting features and peripherals. The CC2541 is highly suited for systems where ultralow power consumption is required. This is specified by various operating modes. Short transition times between operating modes further enable low power consumption.

The CC2541 is pin-compatible with the CC2540 in the 6-mm × 6-mm QFN40 package, if the USB is not used on the CC2540 and the I<sup>2</sup>C/extra I/O is not used on the CC2541. Compared to the CC2540, the CC2541 provides lower RF current consumption. The CC2541 does not have the USB interface of the CC2540, and provides lower maximum output power in TX mode. The CC2541 also adds a HW I<sup>2</sup>C interface.

The CC2541 is pin-compatible with the CC2533 RF4CE-optimized IEEE 802.15.4 SoC.

The CC2541 comes in two different versions: CC2541F128/F256, with 128 KB and 256 KB of flash memory, respectively.

For the CC2541 block diagram, see [Figure 1](#).



This integrated circuit can be damaged by ESD. Texas Instruments recommends that all integrated circuits be handled with appropriate precautions. Failure to observe proper handling and installation procedures can cause damage.

ESD damage can range from subtle performance degradation to complete device failure. Precision integrated circuits may be more susceptible to damage because very small parametric changes could cause the device not to meet its published specifications.

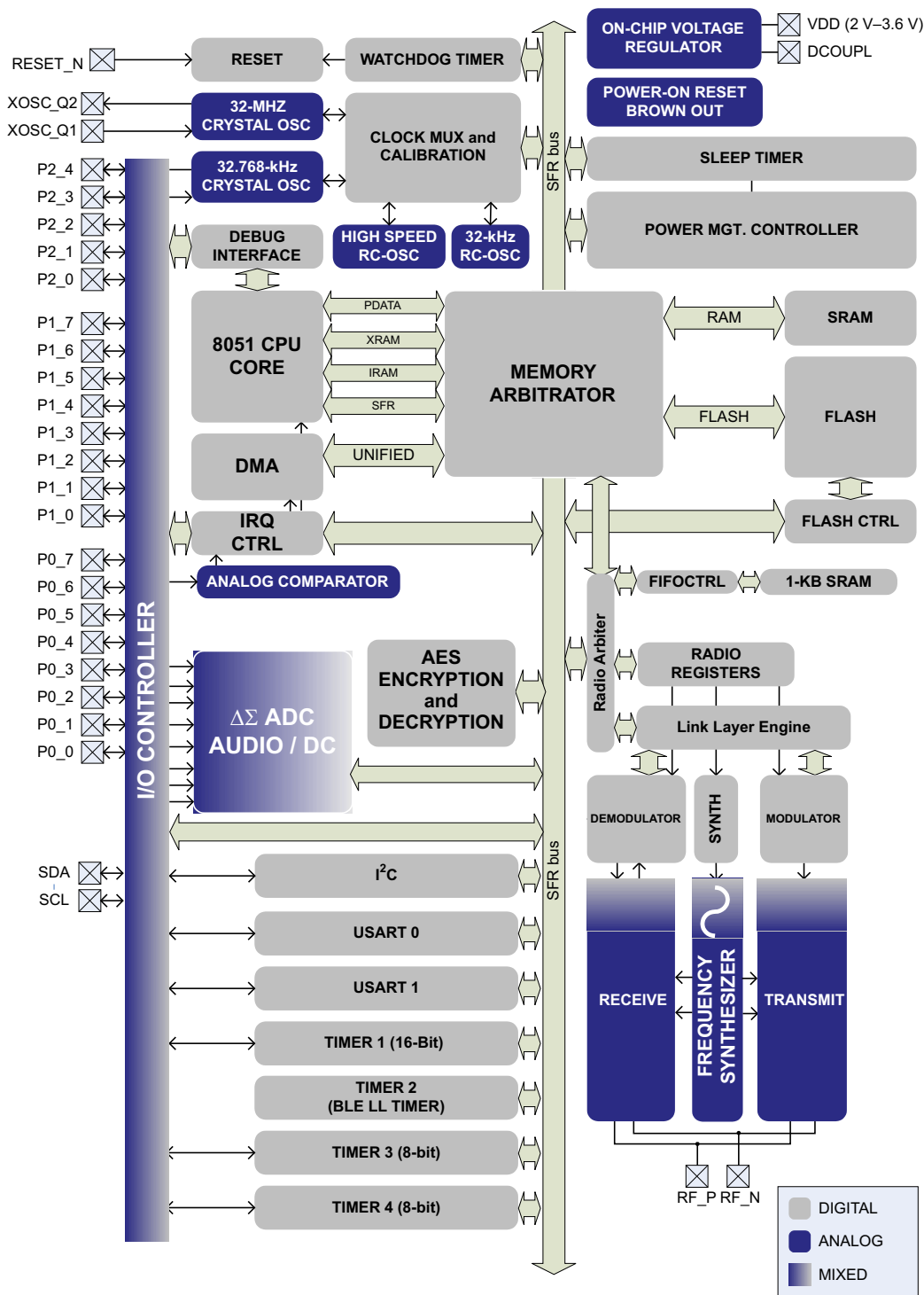

Figure 1. Block Diagram

## ABSOLUTE MAXIMUM RATINGS<sup>(1)</sup>

over operating free-air temperature range (unless otherwise noted)

		MIN	MAX	UNIT
Supply voltage	All supply pins must have the same voltage	-0.3	3.9	V
Voltage on any digital pin		-0.3	VDD + 0.3 ≤ 3.9	V
Input RF level			10	dBm
Storage temperature range		-40	125	°C
ESD <sup>(2)</sup>	All pins, excluding pins 25 and 26, according to human-body model, JEDEC STD 22, method A114		2	kV
	All pins, according to human-body model, JEDEC STD 22, method A114		1	kV
	According to charged-device model, JEDEC STD 22, method C101		500	V

- (1) Stresses beyond those listed under *Absolute Maximum Ratings* may cause permanent damage to the device. These are stress ratings only, and functional operation of the device at these or any other conditions beyond those indicated under *Recommended Operating Conditions* is not implied. Exposure to absolute-maximum-rated conditions for extended periods may affect device reliability.
- (2) **CAUTION:** ESD sensitive device. Precautions should be used when handling the device in order to prevent permanent damage.

## RECOMMENDED OPERATING CONDITIONS

over operating free-air temperature range (unless otherwise noted)

		MIN	NOM	MAX	UNIT
Operating ambient temperature range, T <sub>A</sub>		-40		85	°C
Operating supply voltage		2		3.6	V

## ELECTRICAL CHARACTERISTICS

Measured on Texas Instruments CC2541 EM reference design with T<sub>A</sub> = 25°C and VDD = 3 V, **1 Mbps, GFSK, 250-kHz deviation, Bluetooth low energy mode, and 0.1% BER**

PARAMETER		TEST CONDITIONS		MIN	TYP	MAX	UNIT
I <sub>core</sub>	Core current consumption	RX mode, standard mode, no peripherals active, low MCU activity			17.9		mA
		RX mode, high-gain mode, no peripherals active, low MCU activity			20.2		
		TX mode, -20 dBm output power, no peripherals active, low MCU activity			16.8		
		TX mode, 0 dBm output power, no peripherals active, low MCU activity			18.2		
		Power mode 1. Digital regulator on; 16-MHz RCOSC and 32-MHz crystal oscillator off; 32.768-kHz XOSC, POR, BOD and sleep timer active; RAM and register retention			270		μA
		Power mode 2. Digital regulator off; 16-MHz RCOSC and 32-MHz crystal oscillator off; 32.768-kHz XOSC, POR, and sleep timer active; RAM and register retention			1		
		Power mode 3. Digital regulator off; no clocks; POR active; RAM and register retention			0.5		
		Low MCU activity: 32-MHz XOSC running. No radio or peripherals. Limited flash access, no RAM access.			6.7		mA
I <sub>peri</sub>	Peripheral current consumption (Adds to core current I <sub>core</sub> for each peripheral unit activated)	Timer 1. Timer running, 32-MHz XOSC used			90		μA
		Timer 2. Timer running, 32-MHz XOSC used			90		
		Timer 3. Timer running, 32-MHz XOSC used			60		
		Timer 4. Timer running, 32-MHz XOSC used			70		
		Sleep timer, including 32.753-kHz RCOSC			0.6		
		ADC, when converting			1.2		mA

## GENERAL CHARACTERISTICS

 Measured on Texas Instruments CC2541 EM reference design with  $T_A = 25^\circ\text{C}$  and  $V_{DD} = 3\text{ V}$ 

PARAMETER	TEST CONDITIONS	MIN	TYP	MAX	UNIT
<b>WAKE-UP AND TIMING</b>					
Power mode 1 → Active	Digital regulator on, 16-MHz RCOSC and 32-MHz crystal oscillator off. Start-up of 16-MHz RCOSC		4		μs
Power mode 2 or 3 → Active	Digital regulator off, 16-MHz RCOSC and 32-MHz crystal oscillator off. Start-up of regulator and 16-MHz RCOSC		120		μs
Active → TX or RX	Crystal ESR = 16 Ω. Initially running on 16-MHz RCOSC, with 32-MHz XOSC OFF		500		μs
	With 32-MHz XOSC initially on		180		μs
RX/TX turnaround	Proprietary auto mode		130		μs
	BLE mode		150		
<b>RADIO PART</b>					
RF frequency range	Programmable in 1-MHz steps	2379		2496	MHz
Data rate and modulation format	2 Mbps, GFSK, 500-kHz deviation 2 Mbps, GFSK, 320-kHz deviation 1 Mbps, GFSK, 250-kHz deviation 1 Mbps, GFSK, 160-kHz deviation 500 kbps, MSK 250 kbps, GFSK, 160-kHz deviation 250 kbps, MSK				

## RF RECEIVE SECTION

 Measured on Texas Instruments CC2541 EM reference design with  $T_A = 25^\circ\text{C}$ ,  $V_{DD} = 3\text{ V}$ ,  $f_c = 2440\text{ MHz}$ 

PARAMETER	TEST CONDITIONS	MIN	TYP	MAX	UNIT
<b>2 Mbps, GFSK, 500-kHz Deviation, 0.1% BER</b>					
Receiver sensitivity			-90		dBm
Saturation	BER < 0.1%		-1		dBm
Co-channel rejection	Wanted signal at -67 dBm		-9		dB
In-band blocking rejection	±2 MHz offset, 0.1% BER, wanted signal -67 dBm		-2		dB
	±4 MHz offset, 0.1% BER, wanted signal -67 dBm		36		
	±6 MHz or greater offset, 0.1% BER, wanted signal -67 dBm		41		
Frequency error tolerance <sup>(1)</sup>	Including both initial tolerance and drift. Sensitivity better than -67dBm, 250 byte payload. BER 0.1%	-300		300	kHz
Symbol rate error tolerance <sup>(2)</sup>	Maximum packet length. Sensitivity better than -67dBm, 250 byte payload. BER 0.1%	-120		120	ppm
<b>2 Mbps, GFSK, 320-kHz Deviation, 0.1% BER</b>					
Receiver sensitivity			-86		dBm
Saturation	BER < 0.1%		-7		dBm
Co-channel rejection	Wanted signal at -67 dBm		-12		dB
In-band blocking rejection	±2 MHz offset, 0.1% BER, wanted signal -67 dBm		-1		dB
	±4 MHz offset, 0.1% BER, wanted signal -67 dBm		34		
	±6 MHz or greater offset, 0.1% BER, wanted signal -67 dBm		39		
Frequency error tolerance <sup>(1)</sup>	Including both initial tolerance and drift. Sensitivity better than -67 dBm, 250 byte payload. BER 0.1%	-300		300	kHz
Symbol rate error tolerance <sup>(2)</sup>	Maximum packet length. Sensitivity better than -67 dBm, 250 byte payload. BER 0.1%	-120		120	ppm

(1) Difference between center frequency of the received RF signal and local oscillator frequency

(2) Difference between incoming symbol rate and the internally generated symbol rate

## RF RECEIVE SECTION (continued)

Measured on Texas Instruments CC2541 EM reference design with  $T_A = 25^\circ\text{C}$ ,  $V_{DD} = 3\text{ V}$ ,  $f_c = 2440\text{ MHz}$

PARAMETER	TEST CONDITIONS	MIN	TYP	MAX	UNIT
<b>1 Mbps, GFSK, 250-kHz Deviation, Bluetooth low energy Mode, 0.1% BER</b>					
Receiver sensitivity <sup>(3)(4)</sup>	High-gain mode		-94		dBm
	Standard mode		-88		
Saturation <sup>(4)</sup>	BER < 0.1%		5		dBm
Co-channel rejection <sup>(4)</sup>	Wanted signal -67 dBm		-6		dB
In-band blocking rejection <sup>(4)</sup>	±1 MHz offset, 0.1% BER, wanted signal -67 dBm		-2		dB
	±2 MHz offset, 0.1% BER, wanted signal -67 dBm		26		
	±3 MHz offset, 0.1% BER, wanted signal -67 dBm		34		
	>6 MHz offset, 0.1% BER, wanted signal -67 dBm		33		
Out-of-band blocking rejection <sup>(4)</sup>	Minimum interferer level < 2 GHz (Wanted signal -67 dBm)		-21		dBm
	Minimum interferer level [2 GHz, 3 GHz] (Wanted signal -67 dBm)		-25		
	Minimum interferer level > 3 GHz (Wanted signal -67 dBm)		-7		
Intermodulation <sup>(4)</sup>	Minimum interferer level		-36		dBm
Frequency error tolerance <sup>(5)</sup>	Including both initial tolerance and drift. Sensitivity better than -67dBm, 250 byte payload. BER 0.1%	-250		250	kHz
Symbol rate error tolerance <sup>(6)</sup>	Maximum packet length. Sensitivity better than -67 dBm, 250 byte payload. BER 0.1%	-80		80	ppm
<b>1 Mbps, GFSK, 160-kHz Deviation, 0.1% BER</b>					
Receiver sensitivity <sup>(7)</sup>			-91		dBm
Saturation	BER < 0.1%		0		dBm
Co-channel rejection	Wanted signal 10 dB above sensitivity level		-9		dB
In-band blocking rejection	±1-MHz offset, 0.1% BER, wanted signal -67 dBm		2		dB
	±2-MHz offset, 0.1% BER, wanted signal -67 dBm		24		
	±3-MHz offset, 0.1% BER, wanted signal -67 dBm		27		
	>6-MHz offset, 0.1% BER, wanted signal -67 dBm		32		
Frequency error tolerance <sup>(5)</sup>	Including both initial tolerance and drift. Sensitivity better than -67 dBm, 250-byte payload. BER 0.1%	-200		200	kHz
Symbol rate error tolerance <sup>(6)</sup>	Maximum packet length. Sensitivity better than -67 dBm, 250-byte payload. BER 0.1%	-80		80	ppm
<b>500 kbps, MSK, 0.1% BER</b>					
Receiver sensitivity <sup>(7)</sup>			-99		dBm
Saturation	BER < 0.1%		0		dBm
Co-channel rejection	Wanted signal -67 dBm		-5		dB
In-band blocking rejection	±1-MHz offset, 0.1% BER, wanted signal -67 dBm		20		dB
	±2-MHz offset, 0.1% BER, wanted signal -67 dBm		27		
	>2-MHz offset, 0.1% BER, wanted signal -67 dBm		28		
Frequency error tolerance	Including both initial tolerance and drift. Sensitivity better than -67 dBm, 250-byte payload. BER 0.1%	-150		150	kHz
Symbol rate error tolerance	Maximum packet length. Sensitivity better than -67 dBm, 250-byte payload. BER 0.1%	-80		80	ppm

(3) The receiver sensitivity setting is programmable using a TI BLE stack vendor-specific API command. The default value is standard mode.

(4) Results based on standard-gain mode.

(5) Difference between center frequency of the received RF signal and local oscillator frequency

(6) Difference between incoming symbol rate and the internally generated symbol rate

(7) Results based on high-gain mode.

**RF RECEIVE SECTION (continued)**

 Measured on Texas Instruments CC2541 EM reference design with  $T_A = 25^\circ\text{C}$ ,  $V_{DD} = 3\text{ V}$ ,  $f_c = 2440\text{ MHz}$ 

PARAMETER	TEST CONDITIONS	MIN	TYP	MAX	UNIT
<b>250 kbps, GFSK, 160 kHz Deviation, 0.1% BER</b>					
Receiver sensitivity <sup>(8)</sup>			-98		dBm
Saturation	BER < 0.1%		0		dBm
Co-channel rejection	Wanted signal -67 dBm		-3		dB
In-band blocking rejection	±1-MHz offset, 0.1% BER, wanted signal -67 dBm		23		dB
	±2-MHz offset, 0.1% BER, wanted signal -67 dBm		28		
	>2-MHz offset, 0.1% BER, wanted signal -67 dBm		29		
Frequency error tolerance <sup>(9)</sup>	Including both initial tolerance and drift. Sensitivity better than -67 dBm, 250-byte payload. BER 0.1%	-150		150	kHz
Symbol rate error tolerance <sup>(10)</sup>	Maximum packet length. Sensitivity better than -67 dBm, 250-byte payload. BER 0.1%	-80		80	ppm
<b>250 kbps, MSK, 0.1% BER</b>					
Receiver sensitivity <sup>(11)</sup>			-99		dBm
Saturation	BER < 0.1%		0		dBm
Co-channel rejection	Wanted signal -67 dBm		-5		dB
In-band blocking rejection	±1-MHz offset, 0.1% BER, wanted signal -67 dBm		20		dB
	±2-MHz offset, 0.1% BER, wanted signal -67 dBm		29		
	>2-MHz offset, 0.1% BER, wanted signal -67 dBm		30		
Frequency error tolerance	Including both initial tolerance and drift. Sensitivity better than -67 dBm, 250-byte payload. BER 0.1%	-150		150	kHz
Symbol rate error tolerance	Maximum packet length. Sensitivity better than -67 dBm, 250-byte payload. BER 0.1%	-80		80	ppm
<b>ALL RATES/FORMATS</b>					
Spurious emission in RX. Conducted measurement	f < 1 GHz		-67		dBm
Spurious emission in RX. Conducted measurement	f > 1 GHz		-57		dBm

(8) Results based on standard-gain mode.

(9) Difference between center frequency of the received RF signal and local oscillator frequency

(10) Difference between incoming symbol rate and the internally generated symbol rate

(11) Results based on high-gain mode.

## RF TRANSMIT SECTION

Measured on Texas Instruments CC2541 EM reference design with  $T_A = 25^\circ\text{C}$ ,  $V_{DD} = 3\text{ V}$  and  $f_c = 2440\text{ MHz}$

PARAMETER	TEST CONDITIONS	MIN	TYP	MAX	UNIT
Output power	Delivered to a single-ended 50- $\Omega$ load through a balun using maximum recommended output power setting		0		dBm
	Delivered to a single-ended 50- $\Omega$ load through a balun using minimum recommended output power setting		-23		
Programmable output power range	Delivered to a single-ended 50- $\Omega$ load through a balun using minimum recommended output power setting		23		dB
Spurious emission conducted measurement	$f < 1\text{ GHz}$		-52		dBm
	$f > 1\text{ GHz}$		-48		dBm
	Suitable for systems targeting compliance with worldwide radio-frequency regulations ETSI EN 300 328 and EN 300 440 Class 2 (Europe), FCC CFR47 Part 15 (US), and ARIB STD-T66 (Japan)				
Optimum load impedance	Differential impedance as seen from the RF port (RF_P and RF_N) toward the antenna		70 +j30		$\Omega$

Designs with antenna connectors that require conducted ETSI compliance at 64 MHz should insert an LC resonator in front of the antenna connector. Use a 1.6-nH inductor in parallel with a 1.8-pF capacitor. Connect both from the signal trace to a good RF ground.

## CURRENT CONSUMPTION WITH TPS62730

Measured on Texas Instruments CC2541 TPA62730 EM reference design with  $T_A = 25^\circ\text{C}$ ,  $V_{DD} = 3\text{ V}$  and  $f_c = 2440\text{ MHz}$ , **1 Mbps, GFSK, 250-kHz deviation, Bluetooth™ low energy Mode, 1% BER**<sup>(1)</sup>

PARAMETER	TEST CONDITIONS	MIN	TYP	MAX	UNIT
Current consumption	RX mode, standard mode, no peripherals active, low MCU activity, MCU at 1 MHz		14.7		mA
	RX mode, high-gain mode, no peripherals active, low MCU activity, MCU at 1 MHz		16.7		
	TX mode, -20 dBm output power, no peripherals active, low MCU activity, MCU at 1 MHz		13.1		
	TX mode, 0 dBm output power, no peripherals active, low MCU activity, MCU at 1 MHz		14.3		

(1) 0.1% BER maps to 30.8% PER

## 32-MHz CRYSTAL OSCILLATOR

Measured on Texas Instruments CC2541 EM reference design with  $T_A = 25^\circ\text{C}$  and  $V_{DD} = 3\text{ V}$

PARAMETER	TEST CONDITIONS	MIN	TYP	MAX	UNIT
Crystal frequency			32		MHz
Crystal frequency accuracy requirement <sup>(1)</sup>		-40		40	ppm
ESR Equivalent series resistance		6		60	$\Omega$
$C_0$ Crystal shunt capacitance		1		7	pF
$C_L$ Crystal load capacitance		10		16	pF
Start-up time			0.25		ms
Power-down guard time	The crystal oscillator must be in power down for a guard time before it is used again. This requirement is valid for all modes of operation. The need for power-down guard time can vary with crystal type and load.		3		ms

(1) Including aging and temperature dependency, as specified by [1]



### 32.768-kHz CRYSTAL OSCILLATOR

 Measured on Texas Instruments CC2541 EM reference design with  $T_A = 25^\circ\text{C}$  and  $V_{DD} = 3\text{ V}$ 

PARAMETER	TEST CONDITIONS	MIN	TYP	MAX	UNIT
Crystal frequency			32.768		kHz
Crystal frequency accuracy requirement <sup>(1)</sup>		-40		40	ppm
ESR Equivalent series resistance			40	130	k $\Omega$
$C_0$ Crystal shunt capacitance			0.9	2	pF
$C_L$ Crystal load capacitance			12	16	pF
Start-up time			0.4		s

(1) Including aging and temperature dependency, as specified by [1]

### 32-kHz RC OSCILLATOR

 Measured on Texas Instruments CC2541 EM reference design with  $T_A = 25^\circ\text{C}$  and  $V_{DD} = 3\text{ V}$ .

PARAMETER	TEST CONDITIONS	MIN	TYP	MAX	UNIT
Calibrated frequency <sup>(1)</sup>			32.753		kHz
Frequency accuracy after calibration			$\pm 0.2\%$		
Temperature coefficient <sup>(2)</sup>			0.4		%/ $^\circ\text{C}$
Supply-voltage coefficient <sup>(3)</sup>			3		%/V
Calibration time <sup>(4)</sup>			2		ms

(1) The calibrated 32-kHz RC oscillator frequency is the 32-MHz XTAL frequency divided by 977.

(2) Frequency drift when temperature changes after calibration

(3) Frequency drift when supply voltage changes after calibration

(4) When the 32-kHz RC oscillator is enabled, it is calibrated when a switch from the 16-MHz RC oscillator to the 32-MHz crystal oscillator is performed while SLEEP\_CMD.OSC32K\_CALDIS is set to 0.

### 16-MHz RC OSCILLATOR

 Measured on Texas Instruments CC2541 EM reference design with  $T_A = 25^\circ\text{C}$  and  $V_{DD} = 3\text{ V}$ 

PARAMETER	TEST CONDITIONS	MIN	TYP	MAX	UNIT
Frequency <sup>(1)</sup>			16		MHz
Uncalibrated frequency accuracy			$\pm 18\%$		
Calibrated frequency accuracy			$\pm 0.6\%$		
Start-up time			10		$\mu\text{s}$
Initial calibration time <sup>(2)</sup>			50		$\mu\text{s}$

(1) The calibrated 16-MHz RC oscillator frequency is the 32-MHz XTAL frequency divided by 2.

(2) When the 16-MHz RC oscillator is enabled, it is calibrated when a switch from the 16-MHz RC oscillator to the 32-MHz crystal oscillator is performed while SLEEP\_CMD.OSC\_PD is set to 0.

## RSSI CHARACTERISTICS

Measured on Texas Instruments CC2541 EM reference design with  $T_A = 25^\circ\text{C}$  and  $V_{DD} = 3\text{ V}$

PARAMETER	TEST CONDITIONS	MIN	TYP	MAX	UNIT
<b>2 Mbps, GFSK, 320-kHz Deviation, 0.1% BER and 2 Mbps, GFSK, 500-kHz Deviation, 0.1% BER</b>					
Useful RSSI range <sup>(1)</sup>	Reduced gain by AGC algorithm		64		dB
	High gain by AGC algorithm		64		
RSSI offset <sup>(1)</sup>	Reduced gain by AGC algorithm		79		dBm
	High gain by AGC algorithm		99		
Absolute uncalibrated accuracy <sup>(1)</sup>			±6		dB
Step size (LSB value)			1		dB
<b>All Other Rates/Formats</b>					
Useful RSSI range <sup>(1)</sup>	Standard mode		64		dB
	High-gain mode		64		
RSSI offset <sup>(1)</sup>	Standard mode		98		dBm
	High-gain mode		107		
Absolute uncalibrated accuracy <sup>(1)</sup>			±3		dB
Step size (LSB value)			1		dB

(1) Assuming CC2541 EM reference design. Other RF designs give an offset from the reported value.

## FREQUENCY SYNTHESIZER CHARACTERISTICS

Measured on Texas Instruments CC2541 EM reference design with  $T_A = 25^\circ\text{C}$ ,  $V_{DD} = 3\text{ V}$  and  $f_c = 2440\text{ MHz}$

PARAMETER	TEST CONDITIONS	MIN	TYP	MAX	UNIT
Phase noise, unmodulated carrier	At ±1-MHz offset from carrier		-109		dBc/Hz
	At ±3-MHz offset from carrier		-112		
	At ±5-MHz offset from carrier		-119		

## ANALOG TEMPERATURE SENSOR

Measured on Texas Instruments CC2541 EM reference design with  $T_A = 25^\circ\text{C}$  and  $V_{DD} = 3\text{ V}$

PARAMETER	TEST CONDITIONS	MIN	TYP	MAX	UNIT
Output	Measured using integrated ADC, internal band-gap voltage reference, and maximum resolution		1480		12-bit
Temperature coefficient			4.5		/ $1^\circ\text{C}$
Voltage coefficient			1		0.1 V
Initial accuracy without calibration			±10		$^\circ\text{C}$
Accuracy using 1-point calibration			±5		$^\circ\text{C}$
Current consumption when enabled				0.5	

## COMPARATOR CHARACTERISTICS

$T_A = 25^\circ\text{C}$ ,  $V_{DD} = 3\text{ V}$ . All measurement results are obtained using the CC2541 reference designs, post-calibration.

PARAMETER	TEST CONDITIONS	MIN	TYP	MAX	UNIT
Common-mode maximum voltage			VDD		V
Common-mode minimum voltage			-0.3		
Input offset voltage			1		mV
Offset vs temperature			16		$\mu\text{V}/^\circ\text{C}$
Offset vs operating voltage			4		mV/V
Supply current			230		nA
Hysteresis			0.15		mV

## ADC CHARACTERISTICS

 $T_A = 25^\circ\text{C}$  and  $V_{DD} = 3\text{ V}$ 

PARAMETER		TEST CONDITIONS	MIN	TYP	MAX	UNIT
	Input voltage	VDD is voltage on AVDD5 pin	0		VDD	V
	External reference voltage	VDD is voltage on AVDD5 pin	0		VDD	V
	External reference voltage differential	VDD is voltage on AVDD5 pin	0		VDD	V
	Input resistance, signal	Simulated using 4-MHz clock speed		197		k $\Omega$
	Full-scale signal <sup>(1)</sup>	Peak-to-peak, defines 0 dBFS		2.97		V
ENOB <sup>(1)</sup>	Effective number of bits	Single-ended input, 7-bit setting		5.7		bits
		Single-ended input, 9-bit setting		7.5		
		Single-ended input, 10-bit setting		9.3		
		Single-ended input, 12-bit setting		10.3		
		Differential input, 7-bit setting		6.5		
		Differential input, 9-bit setting		8.3		
		Differential input, 10-bit setting		10		
		Differential input, 12-bit setting		11.5		
		10-bit setting, clocked by RCOSC		9.7		
		12-bit setting, clocked by RCOSC		10.9		
	Useful power bandwidth	7-bit setting, both single and differential		0–20		kHz
THD	Total harmonic distortion	Single ended input, 12-bit setting, –6 dBFS <sup>(1)</sup>		–75.2		dB
		Differential input, 12-bit setting, –6 dBFS <sup>(1)</sup>		–86.6		
	Signal to nonharmonic ratio	Single-ended input, 12-bit setting <sup>(1)</sup>		70.2		dB
		Differential input, 12-bit setting <sup>(1)</sup>		79.3		
		Single-ended input, 12-bit setting, –6 dBFS <sup>(1)</sup>		78.8		
		Differential input, 12-bit setting, –6 dBFS <sup>(1)</sup>		88.9		
CMRR	Common-mode rejection ratio	Differential input, 12-bit setting, 1-kHz sine (0 dBFS), limited by ADC resolution		>84		dB
	Crosstalk	Single ended input, 12-bit setting, 1-kHz sine (0 dBFS), limited by ADC resolution		>84		dB
	Offset	Midscale		–3		mV
	Gain error			0.68%		
DNL	Differential nonlinearity	12-bit setting, mean <sup>(1)</sup>		0.05		LSB
		12-bit setting, maximum <sup>(1)</sup>		0.9		
INL	Integral nonlinearity	12-bit setting, mean <sup>(1)</sup>		4.6		LSB
		12-bit setting, maximum <sup>(1)</sup>		13.3		
		12-bit setting, mean, clocked by RCOSC		10		
		12-bit setting, max, clocked by RCOSC		29		
SINAD (–THD+N)	Signal-to-noise-and-distortion	Single ended input, 7-bit setting <sup>(1)</sup>		35.4		dB
		Single ended input, 9-bit setting <sup>(1)</sup>		46.8		
		Single ended input, 10-bit setting <sup>(1)</sup>		57.5		
		Single ended input, 12-bit setting <sup>(1)</sup>		66.6		
		Differential input, 7-bit setting <sup>(1)</sup>		40.7		
		Differential input, 9-bit setting <sup>(1)</sup>		51.6		
		Differential input, 10-bit setting <sup>(1)</sup>		61.8		
		Differential input, 12-bit setting <sup>(1)</sup>		70.8		
	Conversion time	7-bit setting		20		$\mu\text{s}$
		9-bit setting		36		
		10-bit setting		68		
		12-bit setting		132		

(1) Measured with 300-Hz sine-wave input and VDD as reference.

### ADC CHARACTERISTICS (continued)

T<sub>A</sub> = 25°C and VDD = 3 V

PARAMETER	TEST CONDITIONS	MIN	TYP	MAX	UNIT
Power consumption			1.2		mA
Internal reference VDD coefficient			4		mV/V
Internal reference temperature coefficient			0.4		mV/10°C
Internal reference voltage			1.24		V

### CONTROL INPUT AC CHARACTERISTICS

T<sub>A</sub> = -40°C to 85°C, VDD = 2 V to 3.6 V

PARAMETER	TEST CONDITIONS	MIN	TYP	MAX	UNIT
System clock, f <sub>SYSCLK</sub> t <sub>SYSCLK</sub> = 1/ f <sub>SYSCLK</sub>	The undivided system clock is 32 MHz when crystal oscillator is used. The undivided system clock is 16 MHz when calibrated 16-MHz RC oscillator is used.	16		32	MHz
RESET_N low duration	See item 1, Figure 2. This is the shortest pulse that is recognized as a complete reset pin request. Note that shorter pulses may be recognized but do not lead to complete reset of all modules within the chip.	1			μs
Interrupt pulse duration	See item 2, Figure 2. This is the shortest pulse that is recognized as an interrupt request.	20			ns

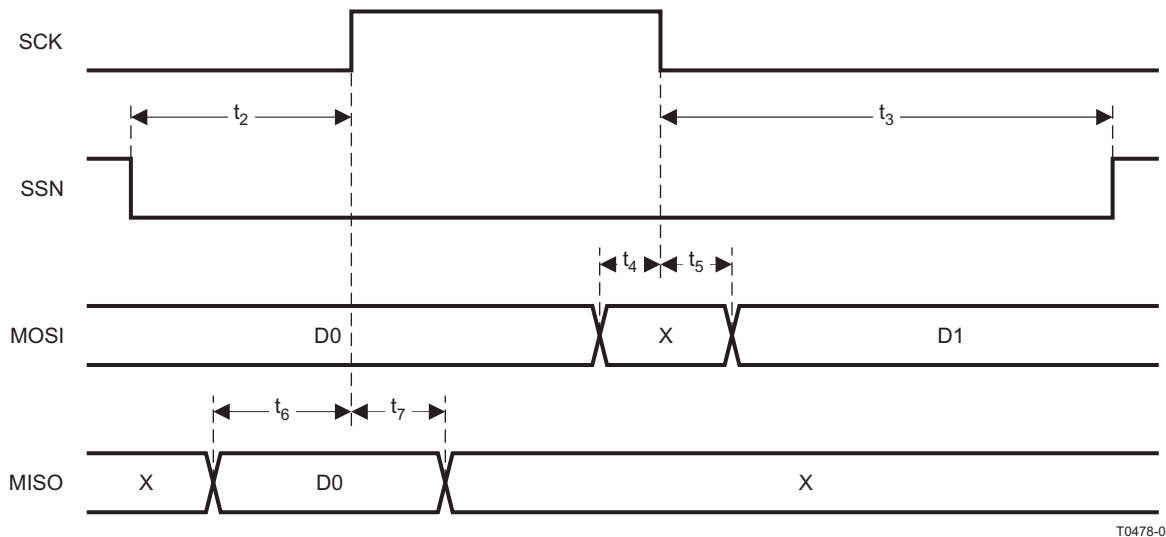

Figure 2. Control Input AC Characteristics

### SPI AC CHARACTERISTICS

T<sub>A</sub> = -40°C to 85°C, VDD = 2 V to 3.6 V

PARAMETER	TEST CONDITIONS	MIN	TYP	MAX	UNIT
t <sub>1</sub> SCK period	Master, RX and TX	250			ns
	Slave, RX and TX	250			
SCK duty cycle	Master		50%		
t <sub>2</sub> SSN low to SCK	Master	63			ns
	Slave	63			
t <sub>3</sub> SCK to SSN high	Master	63			ns
	Slave	63			
t <sub>4</sub> MOSI early out	Master, load = 10 pF			7	ns
t <sub>5</sub> MOSI late out	Master, load = 10 pF			10	ns
t <sub>6</sub> MISO setup	Master	90			ns
t <sub>7</sub> MISO hold	Master	10			ns
SCK duty cycle	Slave		50%		ns
t <sub>10</sub> MOSI setup	Slave	35			ns
t <sub>11</sub> MOSI hold	Slave	10			ns
t <sub>9</sub> MISO late out	Slave, load = 10 pF			95	ns
Operating frequency	Master, TX only			8	MHz
	Master, RX and TX			4	
	Slave, RX only			8	
	Slave, RX and TX			4	



T0478-01

Figure 3. SPI Master AC Characteristics



T0479-01

Figure 4. SPI Slave AC Characteristics

**DEBUG INTERFACE AC CHARACTERISTICS**

$T_A = -40^{\circ}\text{C}$  to  $85^{\circ}\text{C}$ ,  $V_{DD} = 2\text{ V}$  to  $3.6\text{ V}$

PARAMETER	TEST CONDITIONS	MIN	TYP	MAX	UNIT
$f_{\text{clk\_dbg}}$ Debug clock frequency (see Figure 5)				12	MHz
$t_1$ Allowed high pulse on clock (see Figure 5)		35			ns
$t_2$ Allowed low pulse on clock (see Figure 5)		35			ns
$t_3$ EXT_RESET_N low to first falling edge on debug clock (see Figure 7)		167			ns
$t_4$ Falling edge on clock to EXT_RESET_N high (see Figure 7)		83			ns
$t_5$ EXT_RESET_N high to first debug command (see Figure 7)		83			ns
$t_6$ Debug data setup (see Figure 6)		2			ns
$t_7$ Debug data hold (see Figure 6)		4			ns
$t_8$ Clock-to-data delay (see Figure 6)	Load = 10 pF			30	ns

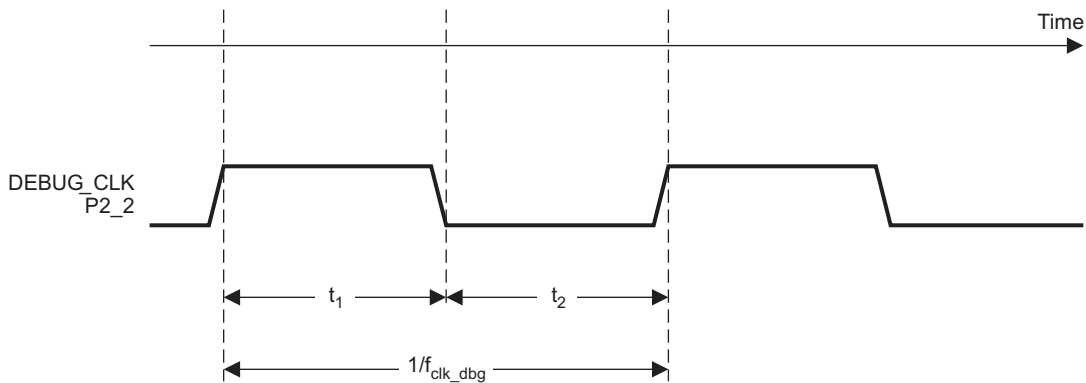

T0436-01

Figure 5. Debug Clock – Basic Timing



T0437-01

Figure 6. Debug Enable Timing

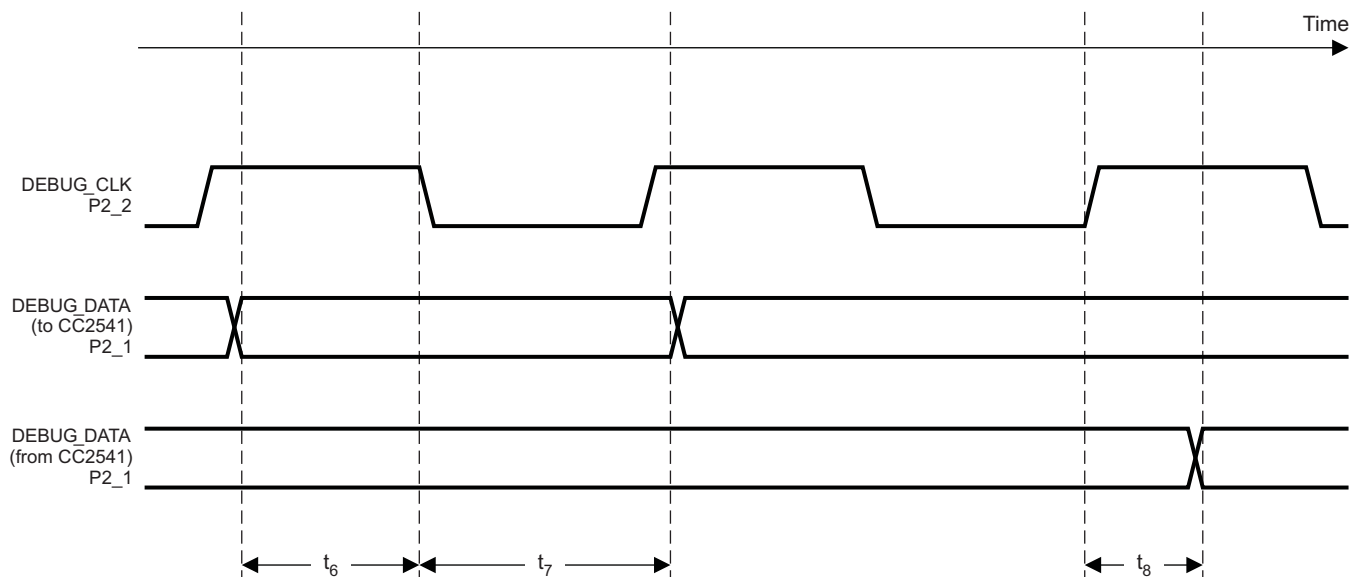

Figure 7. Data Setup and Hold Timing

### TIMER INPUTS AC CHARACTERISTICS

T<sub>A</sub> = -40°C to 85°C, VDD = 2 V to 3.6 V

PARAMETER	TEST CONDITIONS	MIN	TYP	MAX	UNIT
Input capture pulse duration	Synchronizers determine the shortest input pulse that can be recognized. The synchronizers operate at the current system clock rate (16 MHz or 32 MHz).	1.5			t <sub>SYSCLK</sub>

## DC CHARACTERISTICS

T<sub>A</sub> = 25°C, VDD = 3 V

PARAMETER	TEST CONDITIONS	MIN	TYP	MAX	UNIT
Logic-0 input voltage				0.5	V
Logic-1 input voltage		2.4			V
Logic-0 input current	Input equals 0 V	-50		50	nA
Logic-1 input current	Input equals VDD	-50		50	nA
I/O-pin pullup and pulldown resistors			20		kΩ
Logic-0 output voltage, 4- mA pins	Output load 4 mA			0.5	V
Logic-1 output voltage, 4-mA pins	Output load 4 mA	2.5			V
Logic-0 output voltage, 20- mA pins	Output load 20 mA			0.5	V
Logic-1 output voltage, 20-mA pins	Output load 20 mA	2.5			V

## DEVICE INFORMATION

### PIN DESCRIPTIONS

The CC2541 pinout is shown in [Figure 8](#) and a short description of the pins follows.

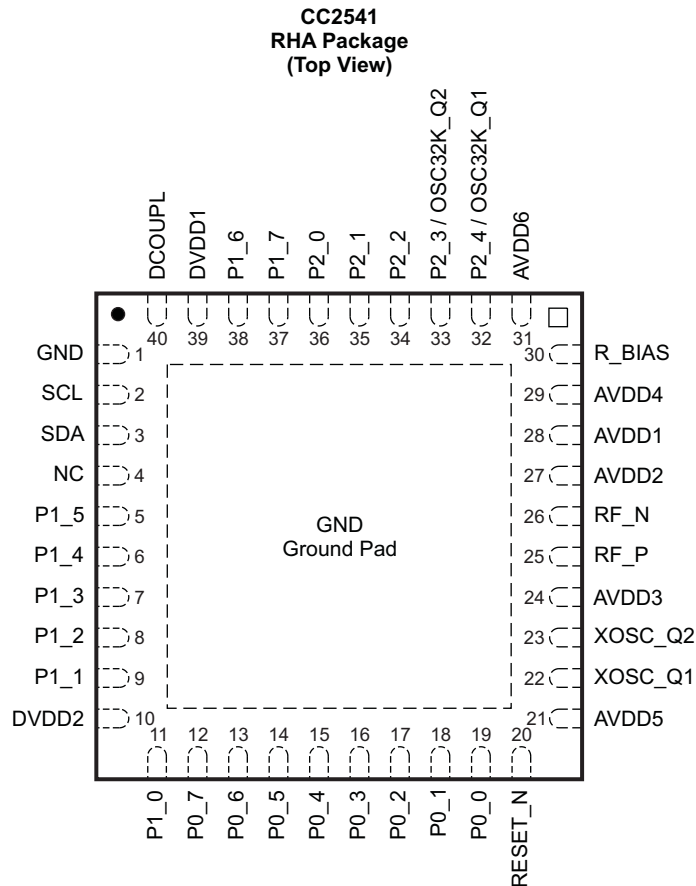

NOTE: The exposed ground pad must be connected to a solid ground plane, as this is the ground connection for the chip.

**Figure 8. Pinout Top View**



**PIN DESCRIPTIONS**

PIN NAME	PIN	PIN TYPE	DESCRIPTION
AVDD1	28	Power (analog)	2-V–3.6-V analog power-supply connection
AVDD2	27	Power (analog)	2-V–3.6-V analog power-supply connection
AVDD3	24	Power (analog)	2-V–3.6-V analog power-supply connection
AVDD4	29	Power (analog)	2-V–3.6-V analog power-supply connection
AVDD5	21	Power (analog)	2-V–3.6-V analog power-supply connection
AVDD6	31	Power (analog)	2-V–3.6-V analog power-supply connection
DCOUPPL	40	Power (digital)	1.8-V digital power-supply decoupling. Do not use for supplying external circuits.
DVDD1	39	Power (digital)	2-V–3.6-V digital power-supply connection
DVDD2	10	Power (digital)	2-V–3.6-V digital power-supply connection
GND	1	Ground pin	Connect to GND
GND	—	Ground	The ground pad must be connected to a solid ground plane.
NC	4	Unused pins	Not connected
P0_0	19	Digital I/O	Port 0.0
P0_1	18	Digital I/O	Port 0.1
P0_2	17	Digital I/O	Port 0.2
P0_3	16	Digital I/O	Port 0.3
P0_4	15	Digital I/O	Port 0.4
P0_5	14	Digital I/O	Port 0.5
P0_6	13	Digital I/O	Port 0.6
P0_7	12	Digital I/O	Port 0.7
P1_0	11	Digital I/O	Port 1.0 – 20-mA drive capability
P1_1	9	Digital I/O	Port 1.1 – 20-mA drive capability
P1_2	8	Digital I/O	Port 1.2
P1_3	7	Digital I/O	Port 1.3
P1_4	6	Digital I/O	Port 1.4
P1_5	5	Digital I/O	Port 1.5
P1_6	38	Digital I/O	Port 1.6
P1_7	37	Digital I/O	Port 1.7
P2_0	36	Digital I/O	Port 2.0
P2_1/DD	35	Digital I/O	Port 2.1 / debug data
P2_2/DC	34	Digital I/O	Port 2.2 / debug clock
P2_3/ OSC32K_Q2	33	Digital I/O, Analog I/O	Port 2.3/32.768 kHz XOSC
P2_4/ OSC32K_Q1	32	Digital I/O, Analog I/O	Port 2.4/32.768 kHz XOSC
RBIAS	30	Analog I/O	External precision bias resistor for reference current
RESET_N	20	Digital input	Reset, active-low
RF_N	26	RF I/O	Negative RF input signal to LNA during RX Negative RF output signal from PA during TX
RF_P	25	RF I/O	Positive RF input signal to LNA during RX Positive RF output signal from PA during TX
SCL	2	I <sup>2</sup> C clock or digital I/O	Can be used as I <sup>2</sup> C clock pin or digital I/O. Leave floating if not used. If grounded disable pull up
SDA	3	I <sup>2</sup> C clock or digital I/O	Can be used as I <sup>2</sup> C data pin or digital I/O. Leave floating if not used. If grounded disable pull up
XOSC_Q1	22	Analog I/O	32-MHz crystal oscillator pin 1 or external clock input
XOSC_Q2	23	Analog I/O	32-MHz crystal oscillator pin 2

### BLOCK DIAGRAM

A block diagram of the CC2541 is shown in Figure 9. The modules can be roughly divided into one of three categories: CPU-related modules; modules related to power, test, and clock distribution; and radio-related modules. In the following subsections, a short description of each module is given.

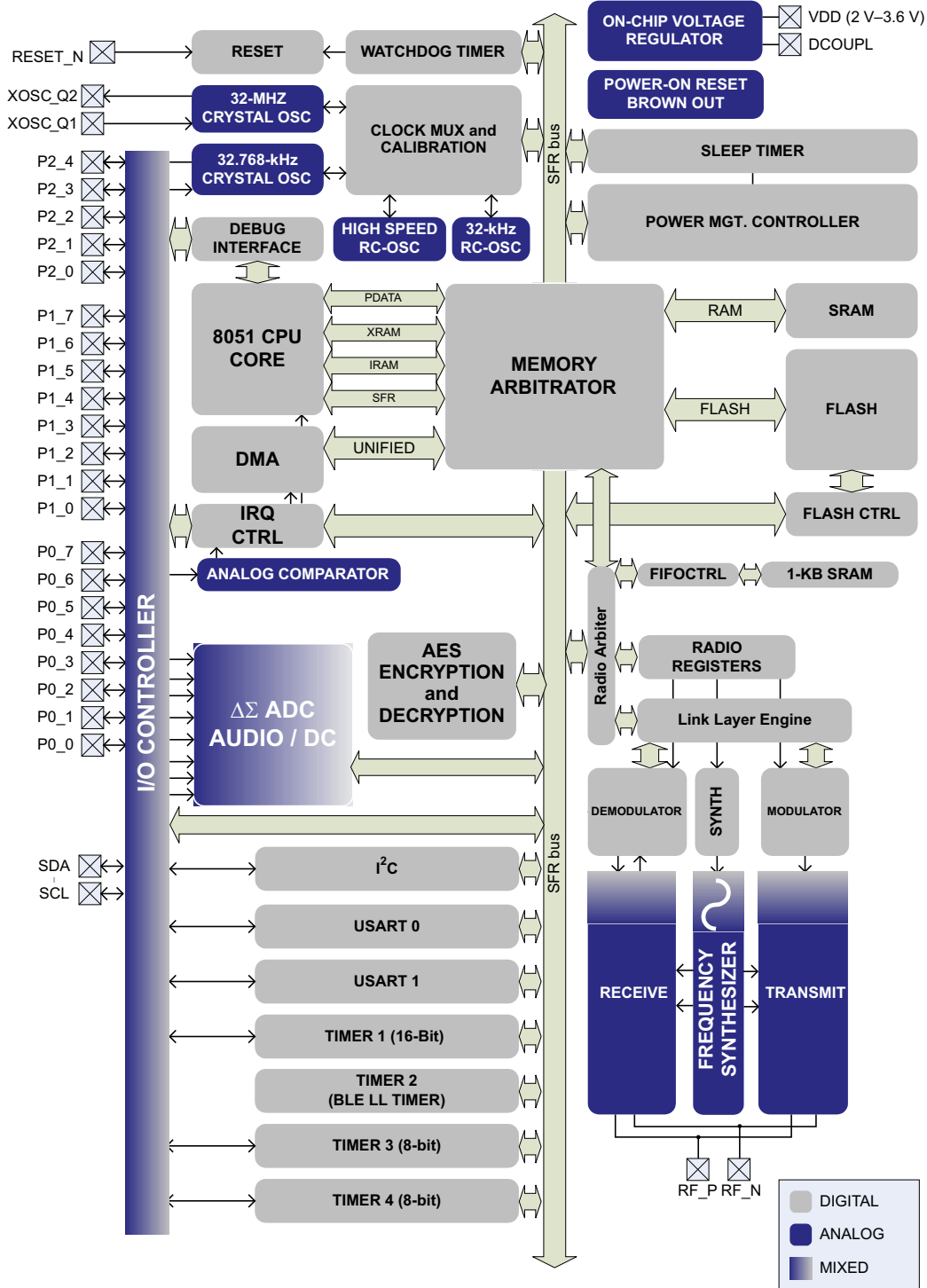

Figure 9. CC2541 Block Diagram

## BLOCK DESCRIPTIONS

A block diagram of the CC2541 is shown in [Figure 9](#). The modules can be roughly divided into one of three categories: CPU-related modules; modules related to power, test, and clock distribution; and radio-related modules. In the following subsections, a short description of each module is given.

### CPU and Memory

The **8051 CPU core** is a single-cycle 8051-compatible core. It has three different memory access busses (SFR, DATA, and CODE/XDATA), a debug interface, and an 18-input extended interrupt unit.

The **memory arbiter** is at the heart of the system, as it connects the CPU and DMA controller with the physical memories and all peripherals through the SFR bus. The memory arbiter has four memory-access points, access of which can map to one of three physical memories: an SRAM, flash memory, and XREG/SFR registers. It is responsible for performing arbitration and sequencing between simultaneous memory accesses to the same physical memory.

The **SFR bus** is drawn conceptually in [Figure 9](#) as a common bus that connects all hardware peripherals to the memory arbiter. The SFR bus in the block diagram also provides access to the radio registers in the radio register bank, even though these are indeed mapped into XDATA memory space.

The **8-KB SRAM** maps to the DATA memory space and to parts of the XDATA memory spaces. The SRAM is an ultralow-power SRAM that retains its contents even when the digital part is powered off (power mode 2 and mode 3).

The **128/256 KB flash block** provides in-circuit programmable non-volatile program memory for the device, and maps into the CODE and XDATA memory spaces.

### Peripherals

Writing to the flash block is performed through a **flash controller** that allows page-wise erasure and 4-bitwise programming. See User Guide for details on the flash controller.

A versatile five-channel **DMA controller** is available in the system, accesses memory using the XDATA memory space, and thus has access to all physical memories. Each channel (trigger, priority, transfer mode, addressing mode, source and destination pointers, and transfer count) is configured with DMA descriptors that can be located anywhere in memory. Many of the hardware peripherals (AES core, flash controller, USARTs, timers, ADC interface, etc.) can be used with the DMA controller for efficient operation by performing data transfers between a single SFR or XREG address and flash/SRAM.

Each CC2541 contains a unique 48-bit IEEE address that can be used as the public device address for a *Bluetooth* device. Designers are free to use this address, or provide their own, as described in the *Bluetooth* specification.

The **interrupt controller** services a total of 18 interrupt sources, divided into six interrupt groups, each of which is associated with one of four interrupt priorities. I/O and sleep timer interrupt requests are serviced even if the device is in a sleep mode (power modes 1 and 2) by bringing the CC2541 back to the active mode.

The **debug interface** implements a proprietary two-wire serial interface that is used for in-circuit debugging. Through this debug interface, it is possible to erase or program the entire flash memory, control which oscillators are enabled, stop and start execution of the user program, execute instructions on the 8051 core, set code breakpoints, and single-step through instructions in the code. Using these techniques, it is possible to perform in-circuit debugging and external flash programming elegantly.

The **I/O controller** is responsible for all general-purpose I/O pins. The CPU can configure whether peripheral modules control certain pins or whether they are under software control, and if so, whether each pin is configured as an input or output and if a pullup or pulldown resistor in the pad is connected. Each peripheral that connects to the I/O pins can choose between two different I/O pin locations to ensure flexibility in various applications.

The **sleep timer** is an ultralow-power timer that can either use an external 32.768-kHz crystal oscillator or an internal 32.753-kHz RC oscillator. The sleep timer runs continuously in all operating modes except power mode 3. Typical applications of this timer are as a real-time counter or as a wake-up timer to get out of power mode 1 or mode 2.

A built-in **watchdog timer** allows the CC2541 to reset itself if the firmware hangs. When enabled by software, the watchdog timer must be cleared periodically; otherwise, it resets the device when it times out.

**Timer 1** is a 16-bit timer with timer/counter/PWM functionality. It has a programmable prescaler, a 16-bit period value, and five individually programmable counter/capture channels, each with a 16-bit compare value. Each of the counter/capture channels can be used as a PWM output or to capture the timing of edges on input signals. It can also be configured in IR generation mode, where it counts timer 3 periods and the output is ANDed with the output of timer 3 to generate modulated consumer IR signals with minimal CPU interaction.

**Timer 2** is a 40-bit timer. It has a 16-bit counter with a configurable timer period and a 24-bit overflow counter that can be used to keep track of the number of periods that have transpired. A 40-bit capture register is also used to record the exact time at which a start-of-frame delimiter is received/transmitted or the exact time at which transmission ends. There are two 16-bit output compare registers and two 24-bit overflow compare registers that can be used to give exact timing for start of RX or TX to the radio or general interrupts.

**Timer 3 and timer 4** are 8-bit timers with timer/counter/PWM functionality. They have a programmable prescaler, an 8-bit period value, and one programmable counter channel with an 8-bit compare value. Each of the counter channels can be used as PWM output.

**USART 0 and USART 1** are each configurable as either an SPI master/slave or a UART. They provide double buffering on both RX and TX and hardware flow control and are thus well suited to high-throughput full-duplex applications. Each USART has its own high-precision baud-rate generator, thus leaving the ordinary timers free for other uses. When configured as SPI slaves, the USARTs sample the input signal using SCK directly instead of using some oversampling scheme, and are thus well-suited for high data rates.

The **AES encryption/decryption core** allows the user to encrypt and decrypt data using the AES algorithm with 128-bit keys. The AES core also supports ECB, CBC, CFB, OFB, CTR, and CBC-MAC, as well as hardware support for CCM.

The **ADC** supports 7 to 12 bits of resolution with a corresponding range of bandwidths from 30-kHz to 4-kHz, respectively. DC and audio conversions with up to eight input channels (I/O controller pins) are possible. The inputs can be selected as single-ended or differential. The reference voltage can be internal, AVDD, or a single-ended or differential external signal. The ADC also has a temperature-sensor input channel. The ADC can automate the process of periodic sampling or conversion over a sequence of channels.

The **I<sup>2</sup>C** module provides a digital peripheral connection with two pins and supports both master and slave operation. I<sup>2</sup>C support is compliant with the NXP I<sup>2</sup>C specification version 2.1 and supports standard mode (up to 100 kbps) and fast mode (up to 400 kbps). In addition, 7-bit device addressing modes are supported, as well as master and slave modes.

The ultralow-power **analog comparator** enables applications to wake up from PM2 or PM3 based on an analog signal. Both inputs are brought out to pins; the reference voltage must be provided externally. The comparator output is connected to the I/O controller interrupt detector and can be treated by the MCU as a regular I/O pin interrupt.

TYPICAL CHARACTERISTICS

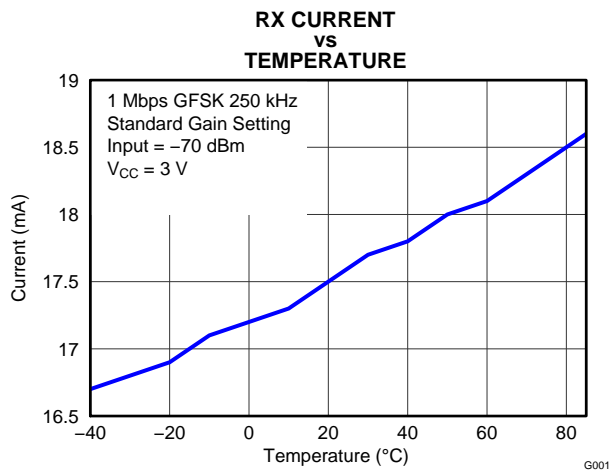

Figure 10.

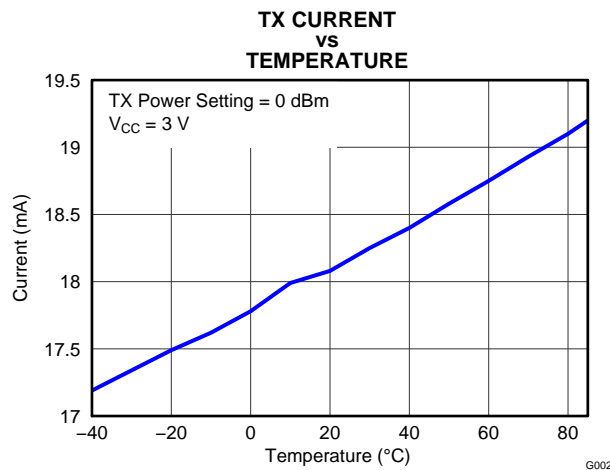

Figure 11.

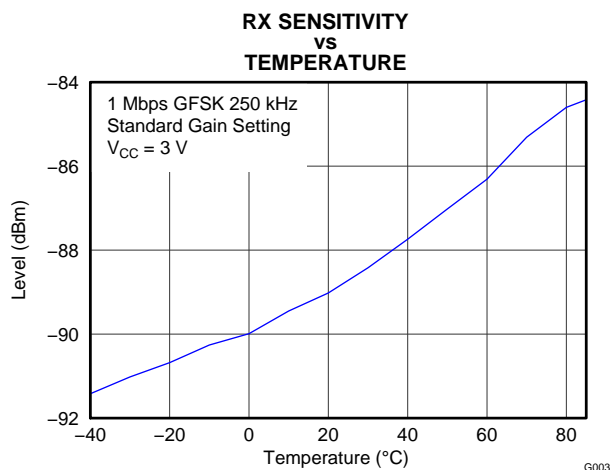

Figure 12.

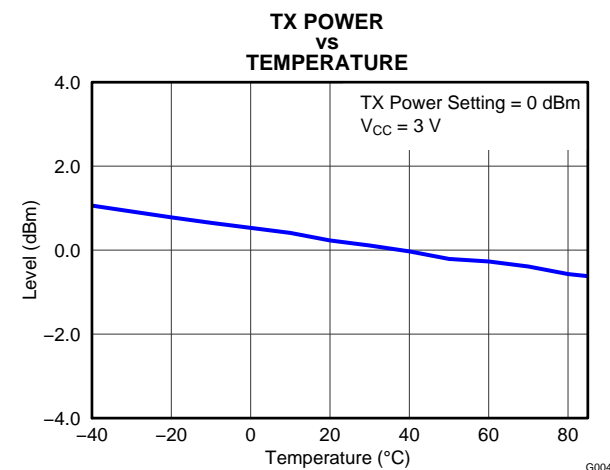

Figure 13.

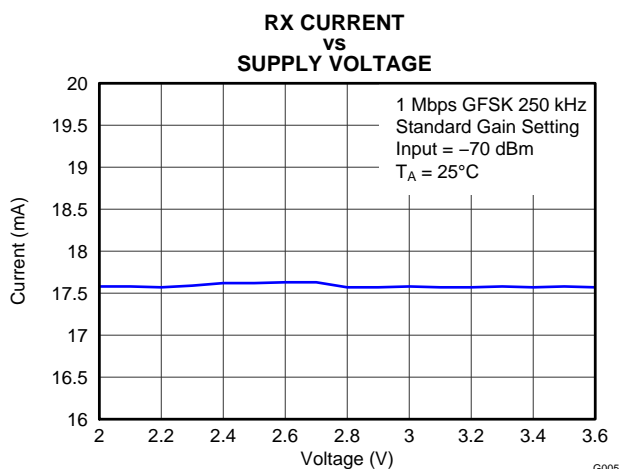

Figure 14.

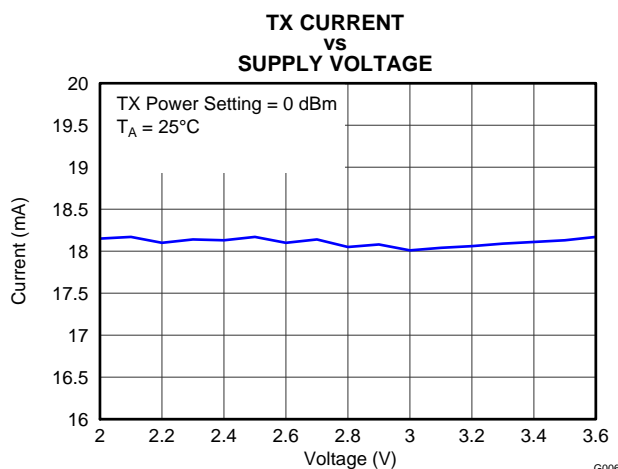

Figure 15.

**TYPICAL CHARACTERISTICS (continued)**

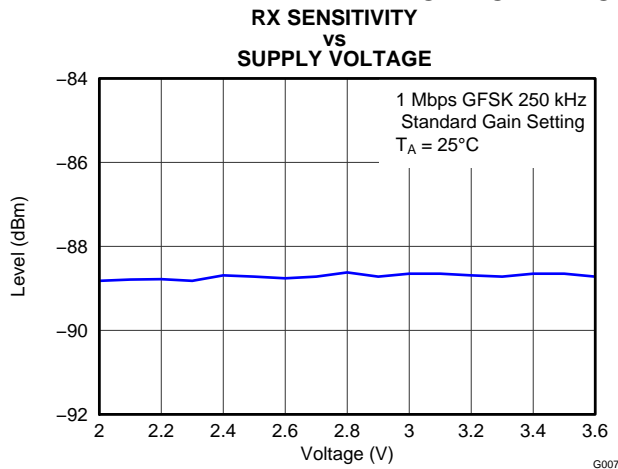

Figure 16.

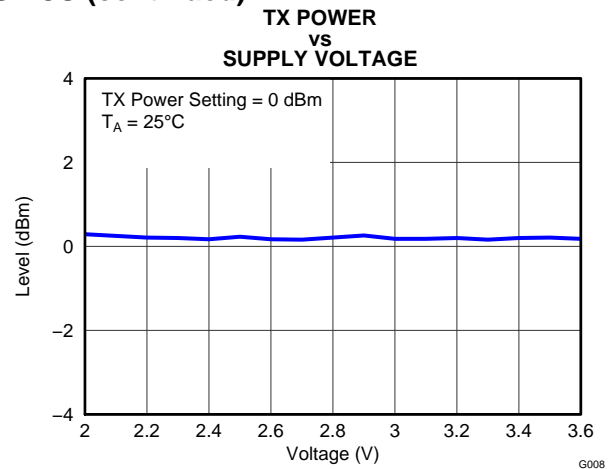

Figure 17.

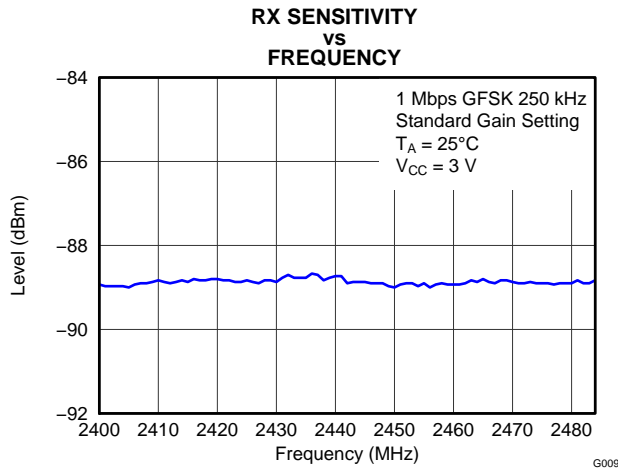

Figure 18.

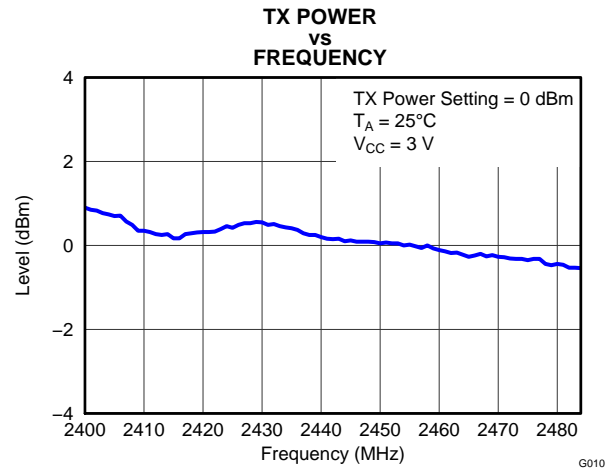

Figure 19.

**Table 1. Output Power<sup>(1)(2)</sup>**

TXPOWER Setting	Typical Output Power (dBm)
0xE1	0
0xD1	-2
0xC1	-4
0xB1	-6
0xA1	-8
0x91	-10
0x81	-12
0x71	-14
0x61	-16
0x51	-18
0x41	-20
0x31	-23

- (1) Measured on Texas Instruments CC2541 EM reference design with  $T_A = 25^\circ\text{C}$ ,  $V_{DD} = 3\text{ V}$  and  $f_c = 2440\text{ MHz}$ . See [SWRU191](#) for recommended register settings.
- (2) 1 Mbps, GFSK, 250-kHz deviation, Bluetooth™ low energy mode, 1% BER

**Table 2. Output Power and Current Consumption**

Typical Output Power (dBm)	Typical Current Consumption (mA) <sup>(1)</sup>	Typical Current Consumption With TPS62730 (mA) <sup>(2)</sup>
0	18.2	14.3
-20	16.8	13.1

- (1) Measured on Texas Instruments CC2541 EM reference design with  $T_A = 25^\circ\text{C}$ ,  $V_{DD} = 3\text{ V}$  and  $f_c = 2440\text{ MHz}$ . See [SWRU191](#) for recommended register settings.
- (2) Measured on Texas Instruments CC2541 TPS62730 EM reference design with  $T_A = 25^\circ\text{C}$ ,  $V_{DD} = 3\text{ V}$  and  $f_c = 2440\text{ MHz}$ . See [SWRU191](#) for recommended register settings.

**TYPICAL CURRENT SAVINGS WHEN USING TPS62730**

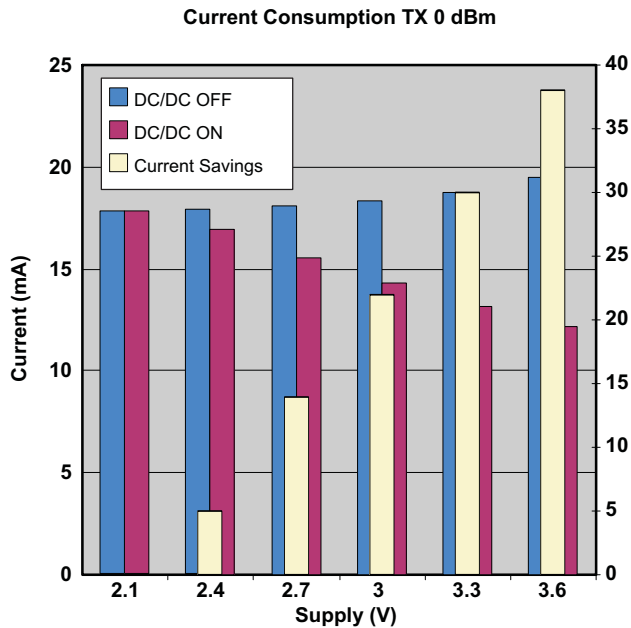

**Figure 20. Current Savings in TX at Room Temperature**

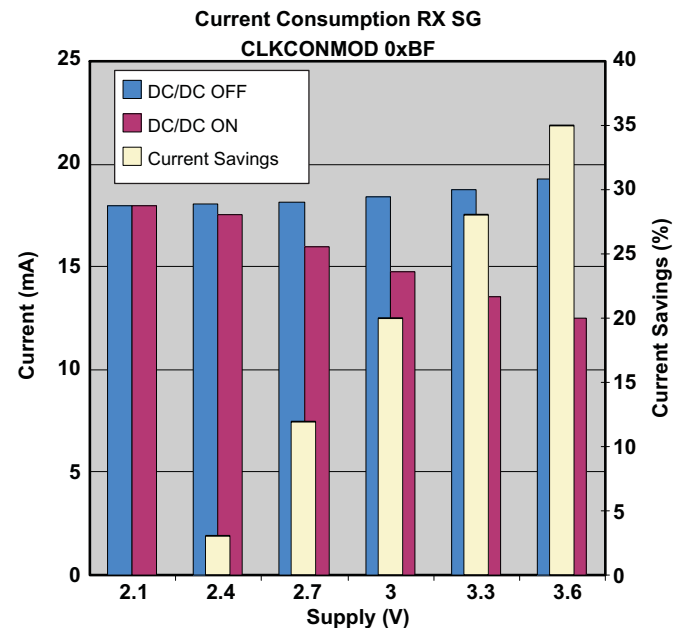
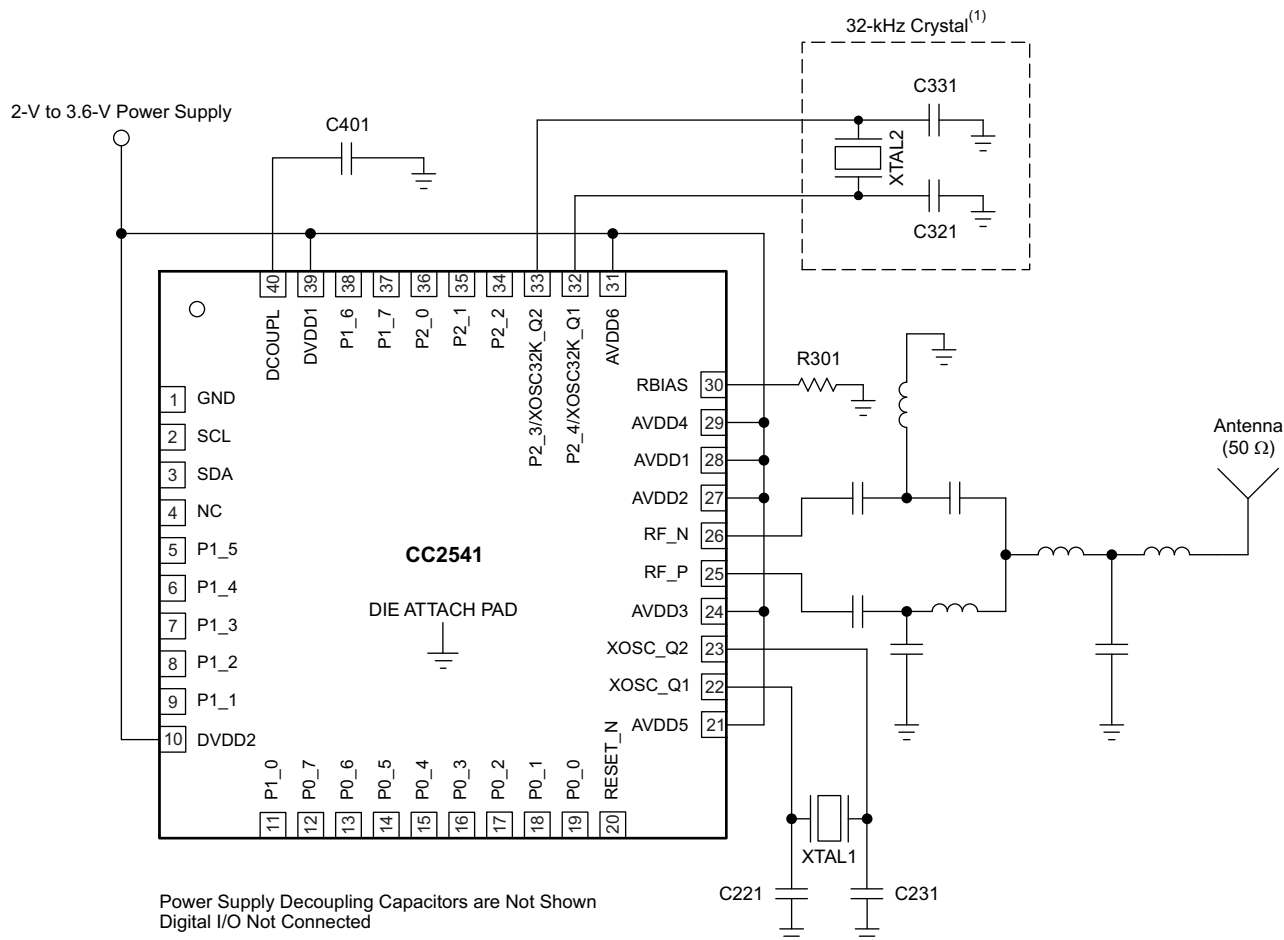

**Figure 21. Current Savings in RX at Room Temperature**

The application note ([SWRA365](#)) has information regarding the CC2541 and TPS62730 combo board and the current savings that can be achieved using the combo board.

### APPLICATION INFORMATION

Few external components are required for the operation of the CC2541. A typical application circuit is shown in Figure 22.



(1) 32-kHz crystal is mandatory when running the BLE protocol stack in low-power modes, except if the link layer is in the standby state (Vol. 6 Part B Section 1.1 in [1]).  
 NOTE: Different antenna alternatives will be provided as reference designs.

**Figure 22. CC2541 Application Circuit**

**Table 3. Overview of External Components (Excluding Supply Decoupling Capacitors)**

Component	Description	Value
C401	Decoupling capacitor for the internal 1.8-V digital voltage regulator	1 μF
R301	Precision resistor ±1%, used for internal biasing	56 kΩ

### Input/Output Matching

When using an unbalanced antenna such as a monopole, a balun should be used to optimize performance. The balun can be implemented using low-cost discrete inductors and capacitors. See reference design, CC2541EM, for recommended balun.



## Crystal

An external 32-MHz crystal, XTAL1, with two loading capacitors (C221 and C231) is used for the 32-MHz crystal oscillator. See [32-MHz CRYSTAL OSCILLATOR](#) for details. The load capacitance seen by the 32-MHz crystal is given by:

$$C_L = \frac{1}{\frac{1}{C_{221}} + \frac{1}{C_{231}}} + C_{\text{parasitic}} \quad (1)$$

XTAL2 is an optional 32.768-kHz crystal, with two loading capacitors (C321 and C331) used for the 32.768-kHz crystal oscillator. The 32.768-kHz crystal oscillator is used in applications where both very low sleep-current consumption and accurate wake-up times are needed. The load capacitance seen by the 32.768-kHz crystal is given by:

$$C_L = \frac{1}{\frac{1}{C_{321}} + \frac{1}{C_{331}}} + C_{\text{parasitic}} \quad (2)$$

A series resistor may be used to comply with the ESR requirement.

## On-Chip 1.8-V Voltage Regulator Decoupling

The 1.8-V on-chip voltage regulator supplies the 1.8-V digital logic. This regulator requires a decoupling capacitor (C401) for stable operation.

## Power-Supply Decoupling and Filtering

Proper power-supply decoupling must be used for optimum performance. The placement and size of the decoupling capacitors and the power supply filtering are very important to achieve the best performance in an application. TI provides a compact reference design that should be followed very closely.

## References

1. *Bluetooth*® Core Technical Specification document, version 4.0  
[http://www.bluetooth.com/SiteCollectionDocuments/Core\\_V40.zip](http://www.bluetooth.com/SiteCollectionDocuments/Core_V40.zip)
2. CC253x System-on-Chip Solution for 2.4-GHz IEEE 802.15.4 and ZigBee® Applications/CC2541 System-on-Chip Solution for 2.4-GHz *Bluetooth* low energy Applications ([SWRU191](#))
3. Current Savings in CC254x Using the TPS62730 ([SWRA365](#)).

## Additional Information

Texas Instruments offers a wide selection of cost-effective, low-power RF solutions for proprietary and standard-based wireless applications for use in industrial and consumer applications. Our selection includes RF transceivers, RF transmitters, RF front ends, and System-on-Chips as well as various software solutions for the sub-1- and 2.4-GHz frequency bands.

In addition, Texas Instruments provides a large selection of support collateral such as development tools, technical documentation, reference designs, application expertise, customer support, third-party and university programs.

The Low-Power RF E2E Online Community provides technical support forums, videos and blogs, and the chance to interact with fellow engineers from all over the world.

With a broad selection of product solutions, end application possibilities, and a range of technical support, Texas Instruments offers the broadest low-power RF portfolio. We make RF easy!

The following subsections point to where to find more information.

## Texas Instruments Low-Power RF Web Site

- Forums, videos, and blogs
- RF design help
- E2E interaction

Join us today at [www.ti.com/lprf-forum](http://www.ti.com/lprf-forum).

## Texas Instruments Low-Power RF Developer Network

Texas Instruments has launched an extensive network of low-power RF development partners to help customers speed up their application development. The network consists of recommended companies, RF consultants, and independent design houses that provide a series of hardware module products and design services, including:

- RF circuit, low-power RF, and ZigBee® design services
- Low-power RF and ZigBee module solutions and development tools
- RF certification services and RF circuit manufacturing

Need help with modules, engineering services or development tools?

Search the Low-Power RF Developer Network tool to find a suitable partner.

[www.ti.com/lprfnetwork](http://www.ti.com/lprfnetwork)

## Low-Power RF eNewsletter

The Low-Power RF eNewsletter keeps you up-to-date on new products, news releases, developers' news, and other news and events associated with low-power RF products from TI. The Low-Power RF eNewsletter articles include links to get more online information.

Sign up today on

[www.ti.com/lprfnewsletter](http://www.ti.com/lprfnewsletter)

## REVISION HISTORY

Changes from Original (January 2012) to Revision A	Page
• Changed data sheet status from Product Preview to Production Data .....	1
Changes from Revision A (February 2012) to Revision B	Page
• Changed the Temperature coefficient Unit value From: mV/°C To: / 0.1°C .....	10
• Changed <a href="#">Figure 22</a> text From: Optional 32-kHz Crystal To: 32-kHz Crystal .....	24
Changes from Revision B (August 2012) to Revision C	Page
• Changed the "Internal reference voltage" TYP value From 1.15 V To: 1.24 V .....	12
• Changed pin XOSC_Q1 Pin Type From Analog O To: Analog I/O, and changed the Pin Description .....	17
• Changed pin XOSC_Q2 Pin Type From Analog O To: Analog I/O .....	17
Changes from Revision C (November 2012) to Revision D	Page
• Changed the RF TRANSMIT SECTION, Output power TYP value From: –20 To: –23 .....	8
• Changed the RF TRANSMIT SECTION, Programmable output power range TYP value From: 20 To: 23 .....	8
• Added row 0x31 to <a href="#">Table 1</a> .....	22

**PACKAGING INFORMATION**

Orderable Device	Status (1)	Package Type	Package Drawing	Pins	Package Qty	Eco Plan (2)	Lead/Ball Finish (6)	MSL Peak Temp (3)	Op Temp (°C)	Device Marking (4/5)	Samples
CC2541F128RHAR	ACTIVE	VQFN	RHA	40	2500	Green (RoHS & no Sb/Br)	CU NIPDAU   CU NIPDAUAG	Level-3-260C-168 HR	-40 to 85	CC2541 F128	<a href="#">Samples</a>
CC2541F128RHAT	ACTIVE	VQFN	RHA	40	250	Green (RoHS & no Sb/Br)	CU NIPDAU   CU NIPDAUAG	Level-3-260C-168 HR	-40 to 85	CC2541 F128	<a href="#">Samples</a>
CC2541F256RHAR	ACTIVE	VQFN	RHA	40	2500	Green (RoHS & no Sb/Br)	CU NIPDAU   CU NIPDAUAG	Level-3-260C-168 HR	-40 to 85	CC2541 F256	<a href="#">Samples</a>
CC2541F256RHAT	ACTIVE	VQFN	RHA	40	250	Green (RoHS & no Sb/Br)	CU NIPDAU   CU NIPDAUAG	Level-3-260C-168 HR	-40 to 85	CC2541 F256	<a href="#">Samples</a>
HPA01215RHAR	ACTIVE	VQFN	RHA	40	2500	Green (RoHS & no Sb/Br)	CU NIPDAU	Level-3-260C-168 HR	-40 to 85	CC2541 F128	<a href="#">Samples</a>
HPA01216RHAR	ACTIVE	VQFN	RHA	40	2500	Green (RoHS & no Sb/Br)	CU NIPDAU	Level-3-260C-168 HR	-40 to 85	CC2541 F256	<a href="#">Samples</a>

(1) The marketing status values are defined as follows:

**ACTIVE:** Product device recommended for new designs.

**LIFEBUY:** TI has announced that the device will be discontinued, and a lifetime-buy period is in effect.

**NRND:** Not recommended for new designs. Device is in production to support existing customers, but TI does not recommend using this part in a new design.

**PREVIEW:** Device has been announced but is not in production. Samples may or may not be available.

**OBSOLETE:** TI has discontinued the production of the device.

(2) Eco Plan - The planned eco-friendly classification: Pb-Free (RoHS), Pb-Free (RoHS Exempt), or Green (RoHS & no Sb/Br) - please check <http://www.ti.com/productcontent> for the latest availability information and additional product content details.

**TBD:** The Pb-Free/Green conversion plan has not been defined.

**Pb-Free (RoHS):** TI's terms "Lead-Free" or "Pb-Free" mean semiconductor products that are compatible with the current RoHS requirements for all 6 substances, including the requirement that lead not exceed 0.1% by weight in homogeneous materials. Where designed to be soldered at high temperatures, TI Pb-Free products are suitable for use in specified lead-free processes.

**Pb-Free (RoHS Exempt):** This component has a RoHS exemption for either 1) lead-based flip-chip solder bumps used between the die and package, or 2) lead-based die adhesive used between the die and leadframe. The component is otherwise considered Pb-Free (RoHS compatible) as defined above.

**Green (RoHS & no Sb/Br):** TI defines "Green" to mean Pb-Free (RoHS compatible), and free of Bromine (Br) and Antimony (Sb) based flame retardants (Br or Sb do not exceed 0.1% by weight in homogeneous material)

(3) MSL, Peak Temp. - The Moisture Sensitivity Level rating according to the JEDEC industry standard classifications, and peak solder temperature.

(4) There may be additional marking, which relates to the logo, the lot trace code information, or the environmental category on the device.

(5) Multiple Device Markings will be inside parentheses. Only one Device Marking contained in parentheses and separated by a "~" will appear on a device. If a line is indented then it is a continuation of the previous line and the two combined represent the entire Device Marking for that device.

<sup>(6)</sup> Lead/Ball Finish - Orderable Devices may have multiple material finish options. Finish options are separated by a vertical ruled line. Lead/Ball Finish values may wrap to two lines if the finish value exceeds the maximum column width.

**Important Information and Disclaimer:** The information provided on this page represents TI's knowledge and belief as of the date that it is provided. TI bases its knowledge and belief on information provided by third parties, and makes no representation or warranty as to the accuracy of such information. Efforts are underway to better integrate information from third parties. TI has taken and continues to take reasonable steps to provide representative and accurate information but may not have conducted destructive testing or chemical analysis on incoming materials and chemicals. TI and TI suppliers consider certain information to be proprietary, and thus CAS numbers and other limited information may not be available for release.

In no event shall TI's liability arising out of such information exceed the total purchase price of the TI part(s) at issue in this document sold by TI to Customer on an annual basis.

**OTHER QUALIFIED VERSIONS OF CC2541 :**

- Automotive: [CC2541-Q1](#)

NOTE: Qualified Version Definitions:

- Automotive - Q100 devices qualified for high-reliability automotive applications targeting zero defects

RHA (S-PVQFN-N40)

PLASTIC QUAD FLATPACK NO-LEAD

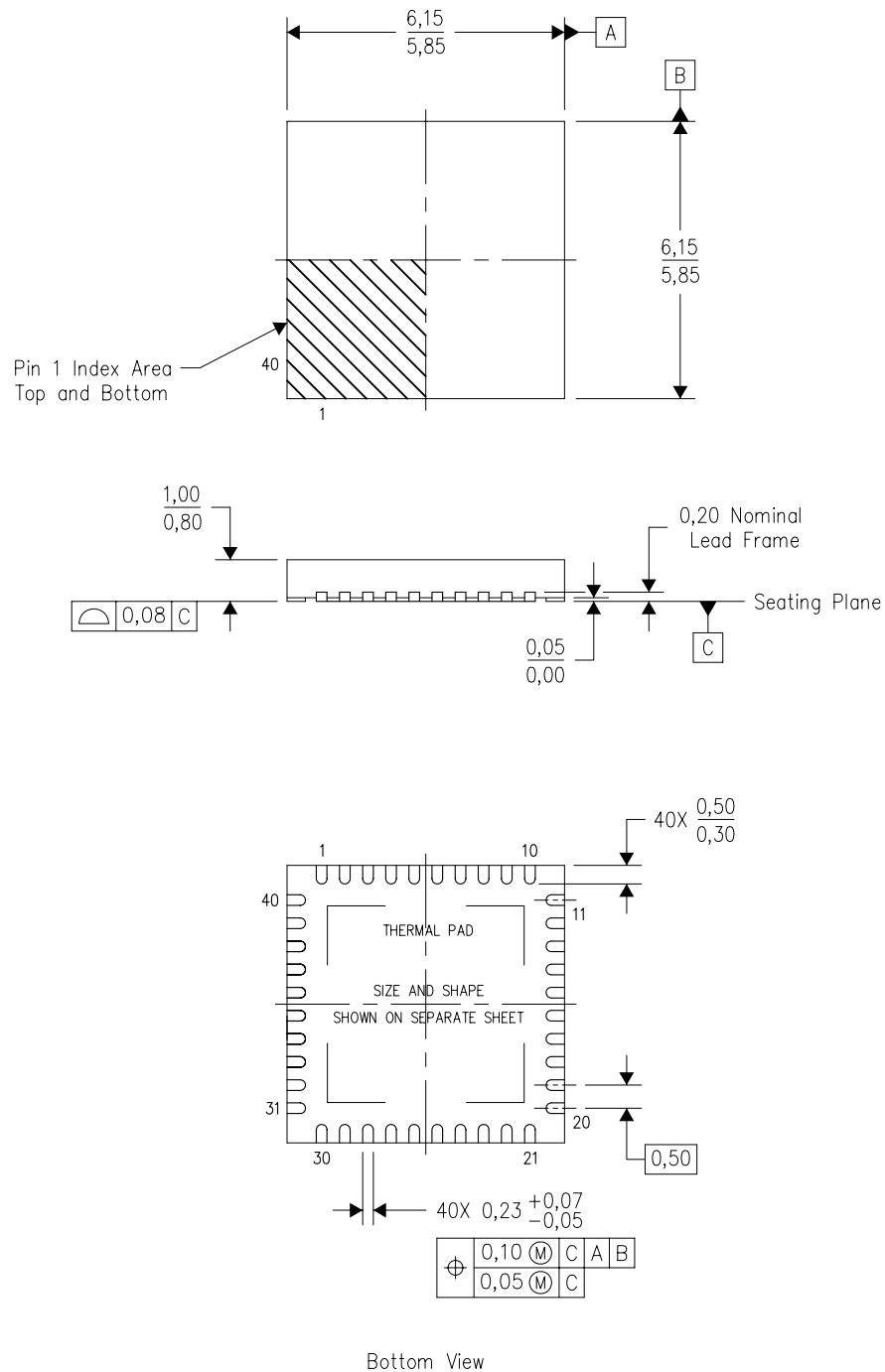

4204276/E 06/11

- NOTES:
- All linear dimensions are in millimeters. Dimensioning and tolerancing per ASME Y14.5M-1994.
  - This drawing is subject to change without notice.
  - QFN (Quad Flatpack No-Lead) Package configuration.
  - The package thermal pad must be soldered to the board for thermal and mechanical performance.
  - See the additional figure in the Product Data Sheet for details regarding the exposed thermal pad features and dimensions.
  - Package complies to JEDEC MO-220 variation VJJD-2.

# THERMAL PAD MECHANICAL DATA

RHA (S-PVQFN-N40)

PLASTIC QUAD FLATPACK NO-LEAD

## THERMAL INFORMATION

This package incorporates an exposed thermal pad that is designed to be attached directly to an external heatsink. The thermal pad must be soldered directly to the printed circuit board (PCB). After soldering, the PCB can be used as a heatsink. In addition, through the use of thermal vias, the thermal pad can be attached directly to the appropriate copper plane shown in the electrical schematic for the device, or alternatively, can be attached to a special heatsink structure designed into the PCB. This design optimizes the heat transfer from the integrated circuit (IC).

For information on the Quad Flatpack No-Lead (QFN) package and its advantages, refer to Application Report, QFN/SON PCB Attachment, Texas Instruments Literature No. SLUA271. This document is available at [www.ti.com](http://www.ti.com).

The exposed thermal pad dimensions for this package are shown in the following illustration.

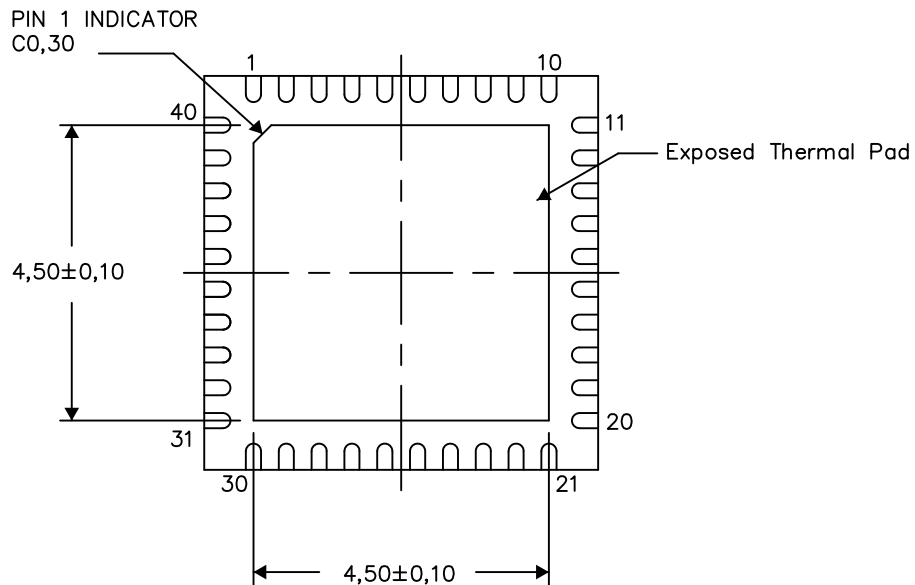

Bottom View

Exposed Thermal Pad Dimensions

4206355-4/X 08/14

NOTES: A. All linear dimensions are in millimeters

RHA (S-PVQFN-N40)

PLASTIC QUAD FLATPACK NO-LEAD

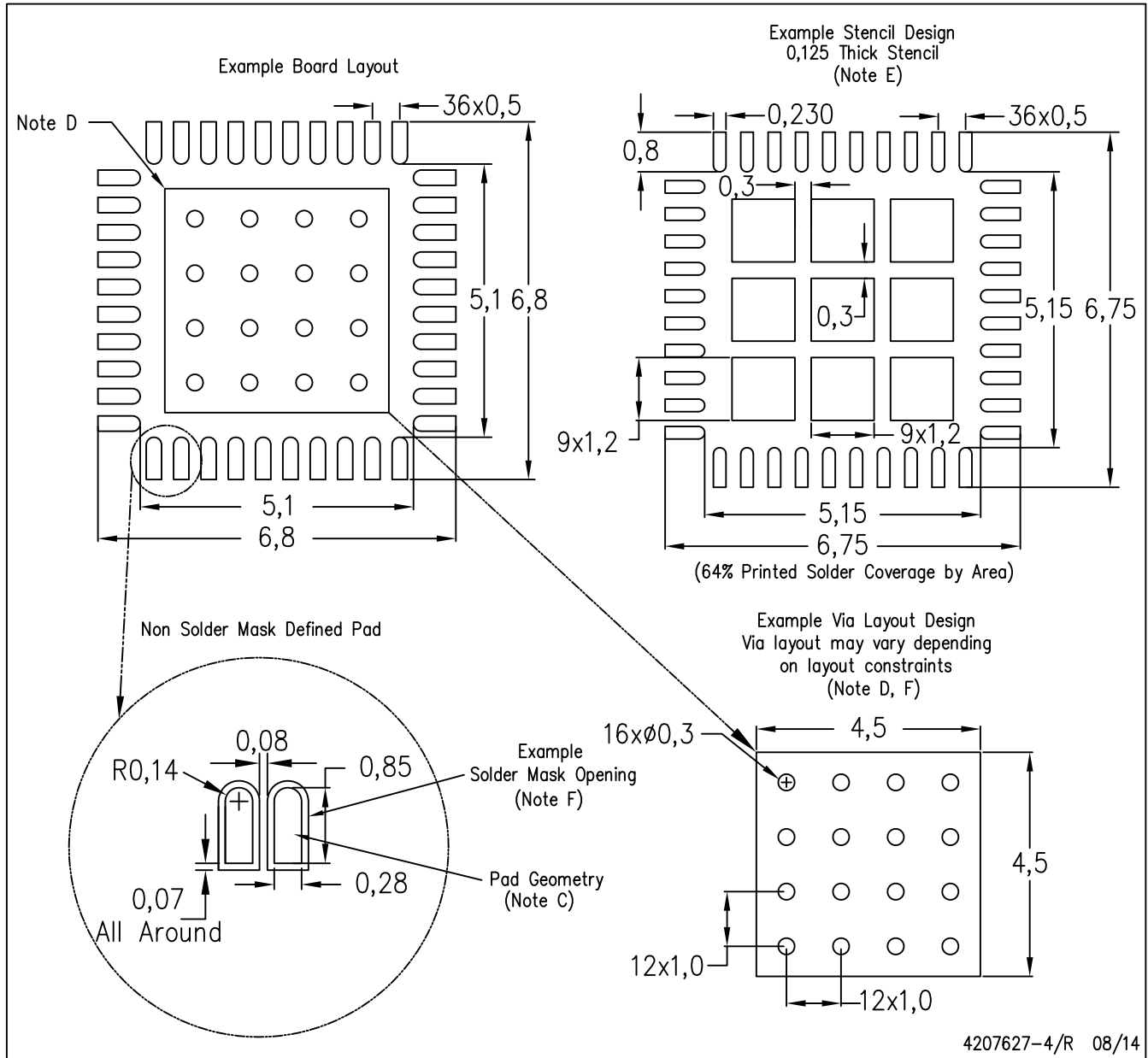

- NOTES:
- All linear dimensions are in millimeters.
  - This drawing is subject to change without notice.
  - Publication IPC-7351 is recommended for alternate designs.
  - This package is designed to be soldered to a thermal pad on the board. Refer to Application Note, Quad Flat-Pack Packages, Texas Instruments Literature No. SLUA271, and also the Product Data Sheets for specific thermal information, via requirements, and recommended board layout. These documents are available at [www.ti.com](http://www.ti.com) <<http://www.ti.com>>.
  - Laser cutting apertures with trapezoidal walls and also rounding corners will offer better paste release. Customers should contact their board assembly site for stencil design recommendations. Refer to IPC 7525 for stencil design considerations.
  - Customers should contact their board fabrication site for recommended solder mask tolerances and via tenting recommendations for vias placed in the thermal pad.

## IMPORTANT NOTICE

Texas Instruments Incorporated (TI) reserves the right to make corrections, enhancements, improvements and other changes to its semiconductor products and services per JESD46, latest issue, and to discontinue any product or service per JESD48, latest issue. Buyers should obtain the latest relevant information before placing orders and should verify that such information is current and complete.

TI's published terms of sale for semiconductor products (<http://www.ti.com/sc/docs/stdterms.htm>) apply to the sale of packaged integrated circuit products that TI has qualified and released to market. Additional terms may apply to the use or sale of other types of TI products and services.

Reproduction of significant portions of TI information in TI data sheets is permissible only if reproduction is without alteration and is accompanied by all associated warranties, conditions, limitations, and notices. TI is not responsible or liable for such reproduced documentation. Information of third parties may be subject to additional restrictions. Resale of TI products or services with statements different from or beyond the parameters stated by TI for that product or service voids all express and any implied warranties for the associated TI product or service and is an unfair and deceptive business practice. TI is not responsible or liable for any such statements.

Buyers and others who are developing systems that incorporate TI products (collectively, "Designers") understand and agree that Designers remain responsible for using their independent analysis, evaluation and judgment in designing their applications and that Designers have full and exclusive responsibility to assure the safety of Designers' applications and compliance of their applications (and of all TI products used in or for Designers' applications) with all applicable regulations, laws and other applicable requirements. Designer represents that, with respect to their applications, Designer has all the necessary expertise to create and implement safeguards that (1) anticipate dangerous consequences of failures, (2) monitor failures and their consequences, and (3) lessen the likelihood of failures that might cause harm and take appropriate actions. Designer agrees that prior to using or distributing any applications that include TI products, Designer will thoroughly test such applications and the functionality of such TI products as used in such applications.

TI's provision of technical, application or other design advice, quality characterization, reliability data or other services or information, including, but not limited to, reference designs and materials relating to evaluation modules, (collectively, "TI Resources") are intended to assist designers who are developing applications that incorporate TI products; by downloading, accessing or using TI Resources in any way, Designer (individually or, if Designer is acting on behalf of a company, Designer's company) agrees to use any particular TI Resource solely for this purpose and subject to the terms of this Notice.

TI's provision of TI Resources does not expand or otherwise alter TI's applicable published warranties or warranty disclaimers for TI products, and no additional obligations or liabilities arise from TI providing such TI Resources. TI reserves the right to make corrections, enhancements, improvements and other changes to its TI Resources. TI has not conducted any testing other than that specifically described in the published documentation for a particular TI Resource.

Designer is authorized to use, copy and modify any individual TI Resource only in connection with the development of applications that include the TI product(s) identified in such TI Resource. NO OTHER LICENSE, EXPRESS OR IMPLIED, BY ESTOPPEL OR OTHERWISE TO ANY OTHER TI INTELLECTUAL PROPERTY RIGHT, AND NO LICENSE TO ANY TECHNOLOGY OR INTELLECTUAL PROPERTY RIGHT OF TI OR ANY THIRD PARTY IS GRANTED HEREIN, including but not limited to any patent right, copyright, mask work right, or other intellectual property right relating to any combination, machine, or process in which TI products or services are used. Information regarding or referencing third-party products or services does not constitute a license to use such products or services, or a warranty or endorsement thereof. Use of TI Resources may require a license from a third party under the patents or other intellectual property of the third party, or a license from TI under the patents or other intellectual property of TI.

TI RESOURCES ARE PROVIDED "AS IS" AND WITH ALL FAULTS. TI DISCLAIMS ALL OTHER WARRANTIES OR REPRESENTATIONS, EXPRESS OR IMPLIED, REGARDING RESOURCES OR USE THEREOF, INCLUDING BUT NOT LIMITED TO ACCURACY OR COMPLETENESS, TITLE, ANY EPIDEMIC FAILURE WARRANTY AND ANY IMPLIED WARRANTIES OF MERCHANTABILITY, FITNESS FOR A PARTICULAR PURPOSE, AND NON-INFRINGEMENT OF ANY THIRD PARTY INTELLECTUAL PROPERTY RIGHTS. TI SHALL NOT BE LIABLE FOR AND SHALL NOT DEFEND OR INDEMNIFY DESIGNER AGAINST ANY CLAIM, INCLUDING BUT NOT LIMITED TO ANY INFRINGEMENT CLAIM THAT RELATES TO OR IS BASED ON ANY COMBINATION OF PRODUCTS EVEN IF DESCRIBED IN TI RESOURCES OR OTHERWISE. IN NO EVENT SHALL TI BE LIABLE FOR ANY ACTUAL, DIRECT, SPECIAL, COLLATERAL, INDIRECT, PUNITIVE, INCIDENTAL, CONSEQUENTIAL OR EXEMPLARY DAMAGES IN CONNECTION WITH OR ARISING OUT OF TI RESOURCES OR USE THEREOF, AND REGARDLESS OF WHETHER TI HAS BEEN ADVISED OF THE POSSIBILITY OF SUCH DAMAGES.

Unless TI has explicitly designated an individual product as meeting the requirements of a particular industry standard (e.g., ISO/TS 16949 and ISO 26262), TI is not responsible for any failure to meet such industry standard requirements.

Where TI specifically promotes products as facilitating functional safety or as compliant with industry functional safety standards, such products are intended to help enable customers to design and create their own applications that meet applicable functional safety standards and requirements. Using products in an application does not by itself establish any safety features in the application. Designers must ensure compliance with safety-related requirements and standards applicable to their applications. Designer may not use any TI products in life-critical medical equipment unless authorized officers of the parties have executed a special contract specifically governing such use. Life-critical medical equipment is medical equipment where failure of such equipment would cause serious bodily injury or death (e.g., life support, pacemakers, defibrillators, heart pumps, neurostimulators, and implantables). Such equipment includes, without limitation, all medical devices identified by the U.S. Food and Drug Administration as Class III devices and equivalent classifications outside the U.S.

TI may expressly designate certain products as completing a particular qualification (e.g., Q100, Military Grade, or Enhanced Product). Designers agree that it has the necessary expertise to select the product with the appropriate qualification designation for their applications and that proper product selection is at Designers' own risk. Designers are solely responsible for compliance with all legal and regulatory requirements in connection with such selection.

Designer will fully indemnify TI and its representatives against any damages, costs, losses, and/or liabilities arising out of Designer's non-compliance with the terms and provisions of this Notice.